



§ SPECIFICATION APPROVAL SHEET §

Fdt Tech Module No **FG043YW000-00R**

Description: **4.3" Digital TFT-LCD Module**

SPEC No.: **SAS-1103005**

Version: **0.0**

Issue Date: **March 17, 2011**

※ This approval sheet contains 12 pages including the cover and appendix.

Customer:

APPROVED BY:

Date: / / 11

APPROVED BY:

CHECKED BY:

DESIGNED BY:



FLAT DISPLAY TECHNOLOGY

4.3" GRAPHIC TFT-LCD Module

■ FG043YW000-00R

1. General Description

FDT Smart Graphic TFT Module is a unique TFT LCD module which builds graphic and character inside. It provides user to present customized & full color graphics or characters without any SOC or IPC system. In addition, user can update or upload his graphics or characters via USB port by himself. FDT Smart Graphic TFT Module not only enhances your product values also saves your cost.



1.1 Features

- Single Operation Voltage +12V
- Full Colors Presentation
- UART Interface For Communication
- Easy To Set Up Without SOC or IPC Controller
- Built In Real Time Clock
- Buzzer Function
- LED Backlight Brightness Control
- USB Port For Update Graphic Library

1.2 Application

- Industrial Controller
- Medical Equipment
- Security Equipment
- Simple Function Equipment



2. Contents

Contents	Page
1. General Description	1
1.1 Features	1
1.2 Applications	1
2. Contents	2
3. Block Diagram	3
3.1 Block Diagram	3
4. Order Information	4
4.1 Unit	4
4.2 Power Cable (Option)	4
5. Specifications	5
6. Absolute Maximum Ratings	5
6.1 Absolute Maximum Ratings	5
7. Recommended operating conditions	6
7.1 Electrical Characteristics	6
8. TFT-LCD Information	6
8.1 TFT-LCD Mechanical Specifications	6
8.2 TFT-LCD Optical Characteristics	6
9. Pin Description	7
9.1 J207B Assignment of Signal Input (Pitch 2.0mm 7Pin,Side Entry Type)	7
9.2 UART Timing Chart (Client side)	7
10. Buzzer Notice	8
10.1 Remove Buzzer Label	8
11. Dimension Information	9-10
11.1 Unit (FG043YW000-00R)	9
11.1 Unit (FG043YW000-00R-2)	10
12. Accessory	11
12.1 LACABLE008-FDR (Option)	11

3. Block Diagram

3.1 Block Diagram

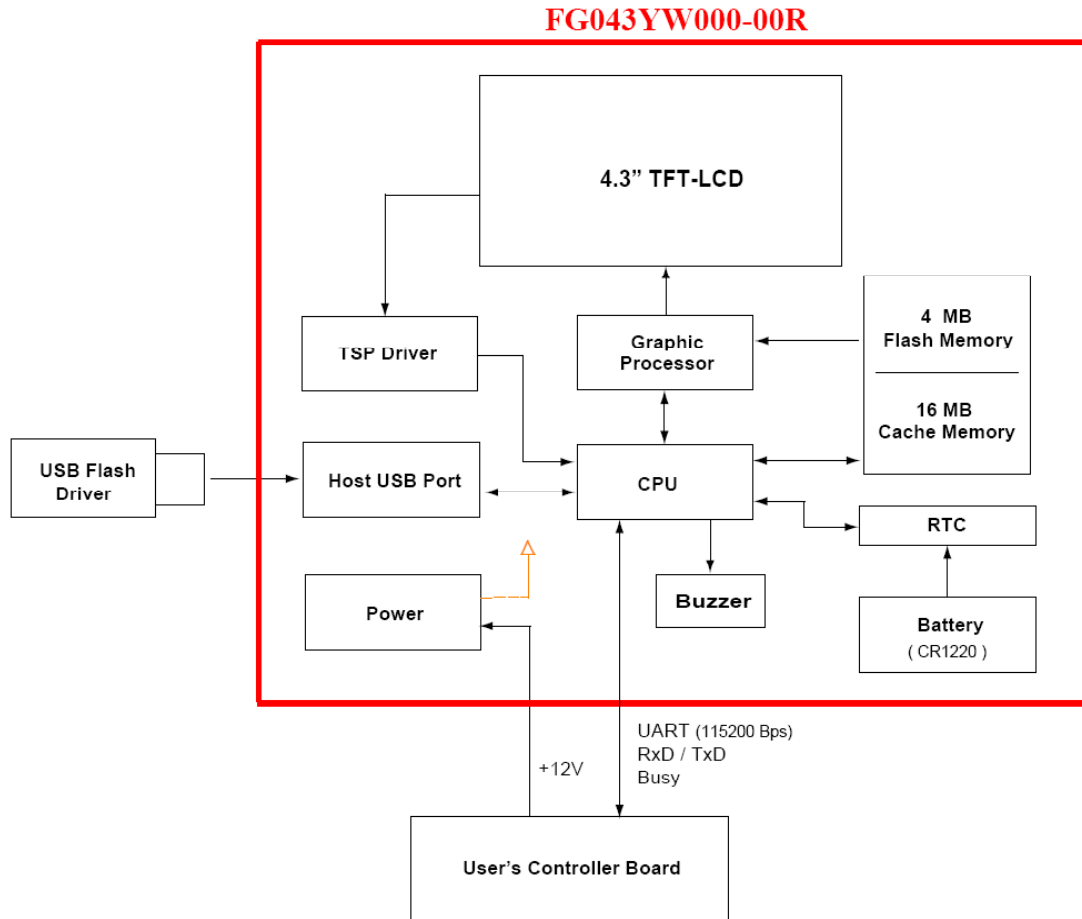

4. Order Information

4.1 Unit

Unit

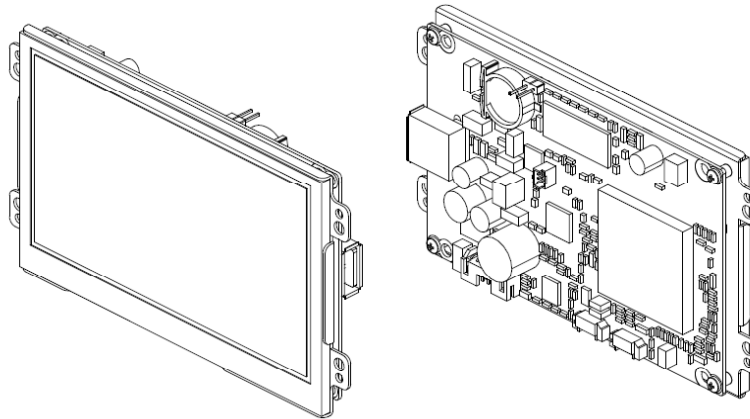

Parameter	FG043YW000-00R	Unit
RTC	<input checked="" type="radio"/>	
Buzzer Function	<input checked="" type="radio"/>	

Note: 1.The tape in back of the bracket is to avoid the panel falling from the unit in delivery.
2.It's Just A temporary adhesion.

4.2 Power Cable (Option)

Power Cable



Order Part Number	Pin Description	Remark
LACABLE008-FDR	7P 2.0mm - 4P1.25mm - 5.5mm-DC Jack	

FLAT DISPLAY TECHNOLOGY

■ FG043YW000-00R V0.0



5. Specifications

Parameter	Specifications	Unit	Remark
Communication Protocol	Duplex Transmission (UART)		
	UART Transmission Rate	115200	Bps
	Data Bit	8	Bits
	Parity Bit Check	NO	
	Stop Bit	1	Bit
USB(TYPE A)	Host	USB 1.1	
Weight	---	g	
Flash ROM	4M	Bytes	Note1
SDRAM	16M	Bytes	
Picture Format	JPEG Category		Note1

NOTE:1 How many pictures in flash memory depend on picture's compression ratio.

6. Absolute Maximum Ratings

6.1 Absolute Maximum Ratings

Parameter	Symbol	Min	Max	Unit	Remark
Input Voltage	V _{in}	+9	+15	V	
Digital Input Signal	TTL	+0.3	+3.6	V	
Operating Temperature		-20	+70	°C	
Storage Temperature		-30	+80	°C	

FLAT DISPLAY TECHNOLOGY

■ FG043YW000-00R V0.0



7. Recommended Operating Conditions

7.1 Electrical Characteristics

Parameter	Symbol	Min	Typ	Max	Unit	Note
Input Voltage	Vin	+10	+12	+14	V	
Total Current	Lin	-	211	-	mA	
Power Consumption		-	2.53	-	W	
I/O	TTL	+0.1	-	+3.3	V	

8. TFT-LCD Information

8.1 TFT-LCD Mechanical Specifications

Parameter	Specifications	Unit
Screen Size	4.3 (Diagonal)	inch
Display Format	480 x (R.G.B) x 272	dot
Active Area	95.04 (W) x 53.856 (H)	mm
Surface Treatment	Antiglare, Hard-Coating (3H)	

8.2 TFT-LCD Optical Characteristics

Parameter	Symbol	Condition	Min	Typ	Max	Unit	Remark
Viewing Angle	Horizontal	Left	65	75	---	deg	
		Right	65	75	---	deg	
	Vertical	Top	50	60	---	deg	
		Bottom	60	70	---	deg	
Contrast Ratio	CR	$\theta = 0^\circ$	480	600	---	---	
Brightness	L	$\theta = 0^\circ$	450	500	---	Cd/m ²	
LED Life Time		+25°	20000	---	---	Hrs	

9. Pin Description

9.1 J207B Pin Assignment of Signal Input (Pitch 2.0mm 7Pin, Side Entry Type)

※ Connector Part No.: M24267R (STM) or S7B-PH-K-S (JST); Matching Connector Part No.: P24267 (STM) or PHR-7 (JST)

Pin No	Symbol	I/O	Description	Remark
1	VCC12V	-	+12V Input Voltage	DC
2	VCC12V	-	+12V Input Voltage	DC
3	GND	-	Ground	
4	GND	-	Ground	
5	BUSY	O	Busy status (Internal pull high)	High: Busy Low: Normal (Note1)
6	RXD	I	Receive Data (UART)	TTL Level RS-232 (3.3V)
7	TXD	O	Transmit Data (UART)	TTL Level RS-232 (3.3V)

Note1: Your application circuit board must be connects with busy pin of SGM.

9.2 UART Timing Chart (Client side)

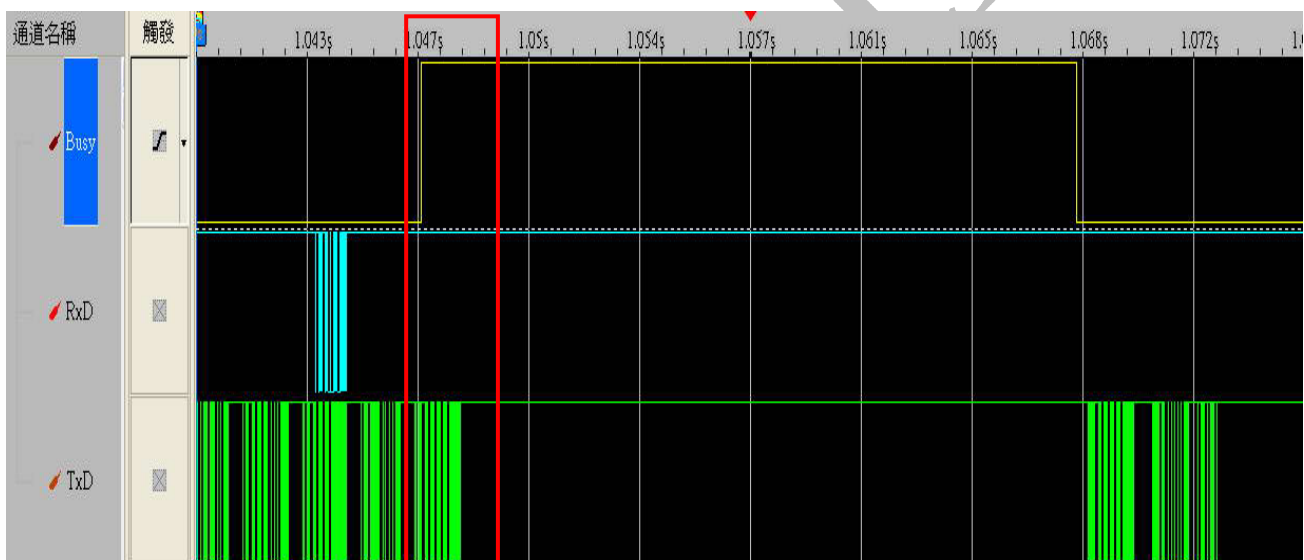

※ If busy signal of SGM appears on the duration of client processor transmission command.
Please don't worry this situation and goes on last command procedure.

10. Buzzer Notice

10.1 Remove Buzzer Label

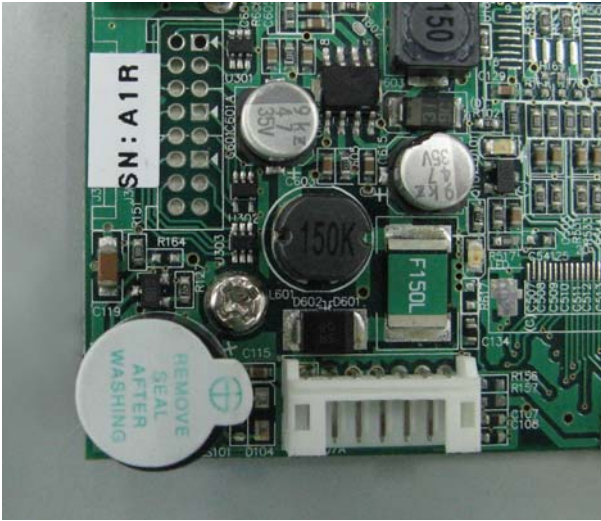

Remove

Tentati



11. Dimension Information

11.1 Unit (FG043YW000-00R)

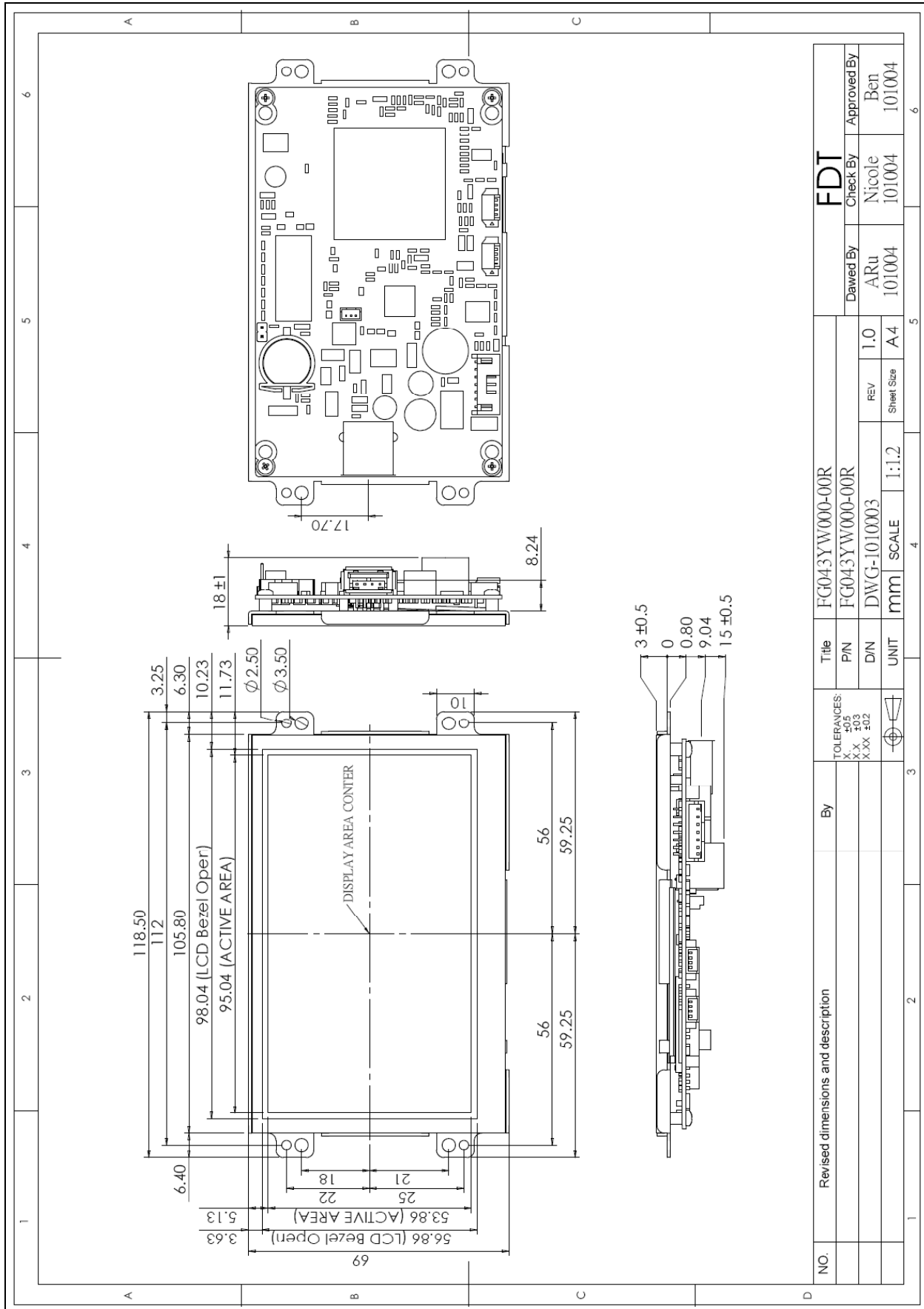

FLAT DISPLAY TECHNOLOGY

FG043YW000-00R V0.0



11.2 Unit (FG043YW000-00R-2)

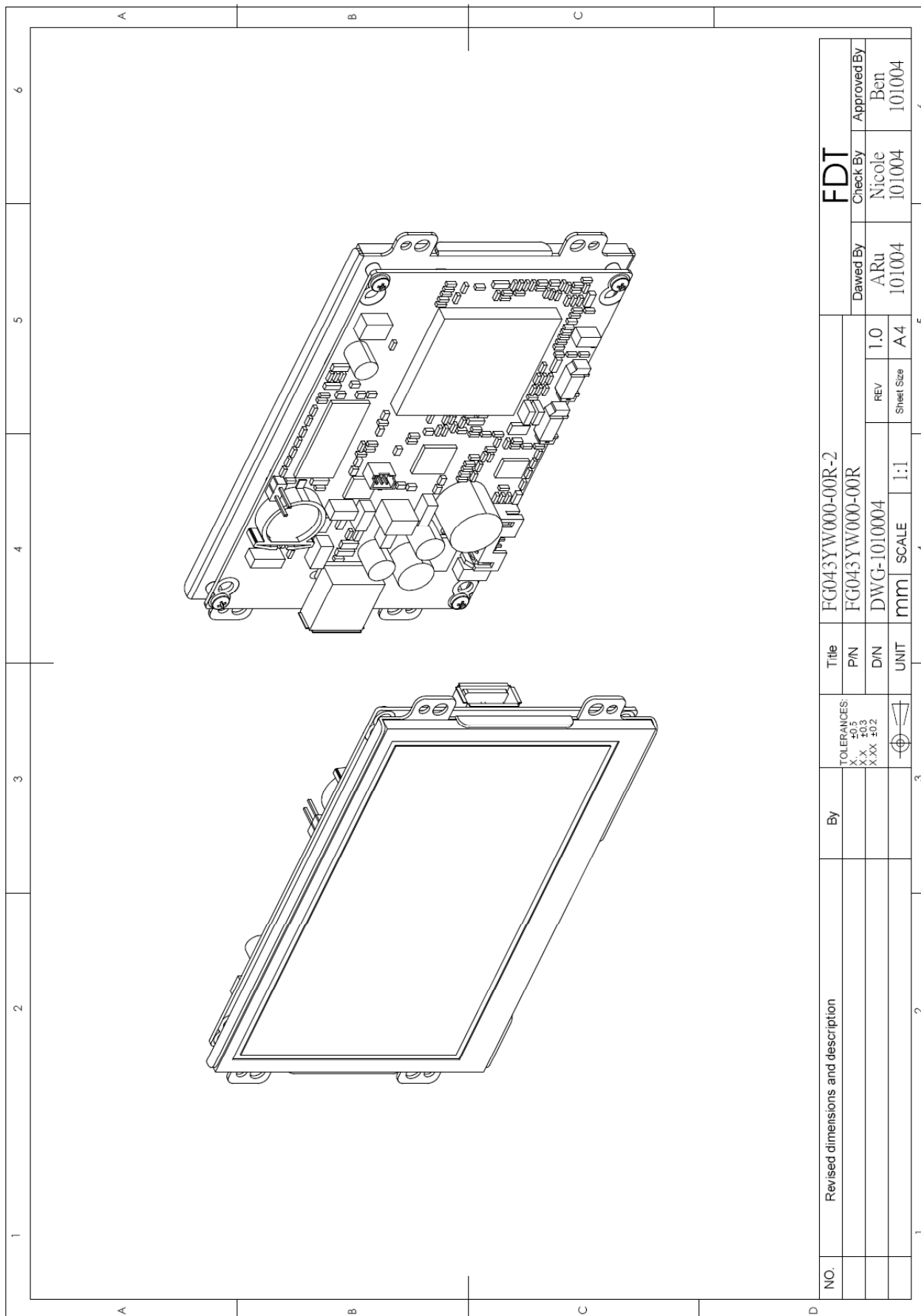

NO.	Revised dimensions and description	By	TOLERANCES: X.X ±0.5 X.X ±0.3 X.XX ±0.2	UNIT	Title		Dated By		Check By		Approved By	
					mm	SCALE	1:1	ARu	101004	Nicole	101004	Ben
					DWG-1010004	REV	1.0					
					FG043YW000-00R-2	Sheet Size	A4					
					FG043YW000-00R							
					UNIT							

FDT



12. Accessory

12.1 LACABLE008-FDR (Option)

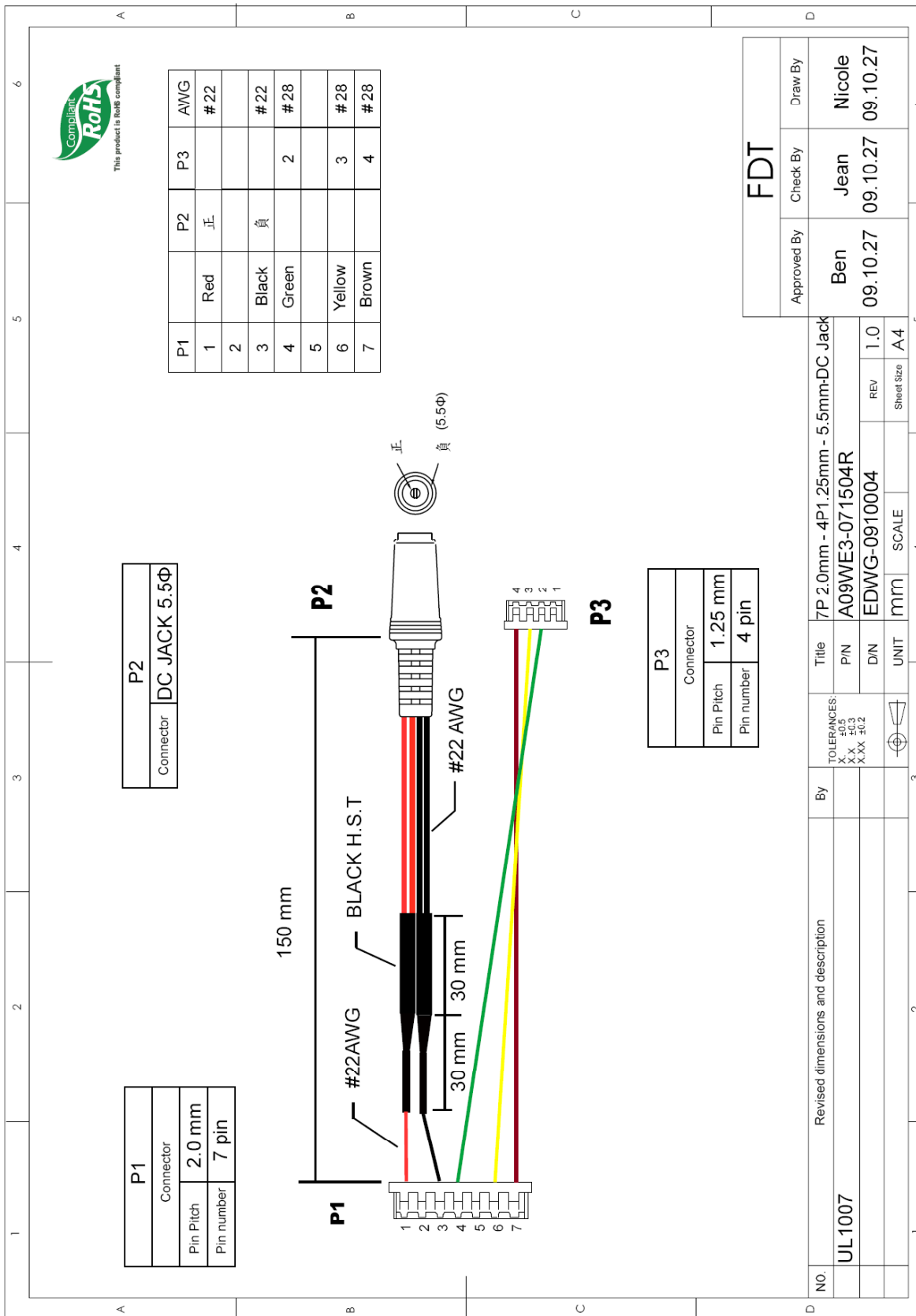

FLAT DISPLAY TECHNOLOGY

FG043YW000-00R V0.0

