



§ SPECIFICATION APPROVAL SHEET §

Fdt Tech Module No	FG0804W00X-00R
Description:	8" Digital TFT-LCD Module
SPEC No.:	SAS-1003006
Version:	0.0
Issue Date:	January 4, 2011

※ This approval sheet contains 15 pages including the cover and appendix.

Customer:	APPROVED BY:
Date: / / 11	

APPROVED BY:

CHECKED BY:

DESIGNED BY:



FLAT DISPLAY TECHNOLOGY

8" GRAPHIC TFT-LCD Module

- FG0804W000-00R
- FG0804W001-00R

1. General Description

FDT Smart Graphic TFT Module is a unique TFT LCD module which builds graphic and character inside. It provides user to present customized & full color graphics or characters without any SOC or IPC system. In addition, user can update or upload his graphics or characters via USB port by himself. FDT Smart Graphic TFT Module not only enhances your product values also saves your cost.



1.1 Features

- Single Operation Voltage +12V
- Full Colors Presentation
- UART Interface For Communication
- Easy To Set Up Without SOC Or IPC Controller
- Built In Real Time Clock
- Buzzer Function
- LED Backlight Brightness Control
- Touch Screen Function (Option)
- USB Port For Update Graphic Library

1.2 Application

- Industrial Controller
- Medical Equipment
- Security Equipment
- Simple Function Equipment



2. Contents

Contents	Page
1. General Description	1
1.1 Features	1
1.2 Applications	1
2. Contents	2
3. Block Diagram	3
3.1 Block Diagram	3
4. Order Information	4
4.1 Unit	4
4.2 Power Cable (Option)	4
5. Specifications	5
6. Absolute Maximum Ratings	5
6.1 Absolute Maximum Ratings	5
7. Recommended operating conditions	6
7.1 Electrical Characteristics	6
8. TFT-LCD Information	6
8.1 TFT-LCD Mechanical Specifications	6
8.2 TFT-LCD Optical Characteristics	6
9. Pin Description	7
9.1 J107A Assignment of Signal Input (Pitch 2.0mm 7Pin,Side Entry Type)	7
9.2 UART Timing Chart(Client side)	7
10. 4W Resistance Touch Panel Characteristics	8
10.1 Touch Screen Integration Design Guide	8
10.2 Mechanical Performance	8
10.3 Durability Performance	8
11. Buzzer Notice	9
11.1 Remove Buzzer Label	9
12.Dimension Information	10-13
12.1Unit(FG0804W000-00R)	10
12.2Unit(FG0804W000-00R-2)	11
12.3Unit(FG0804W001-00R)	12
12.4Unit(FG0804W001-00R-2)	13
13. Accessory	14
13.1 LACABLE008-FDR (Option)	14

3. Block Diagram

3.1 Block Diagram

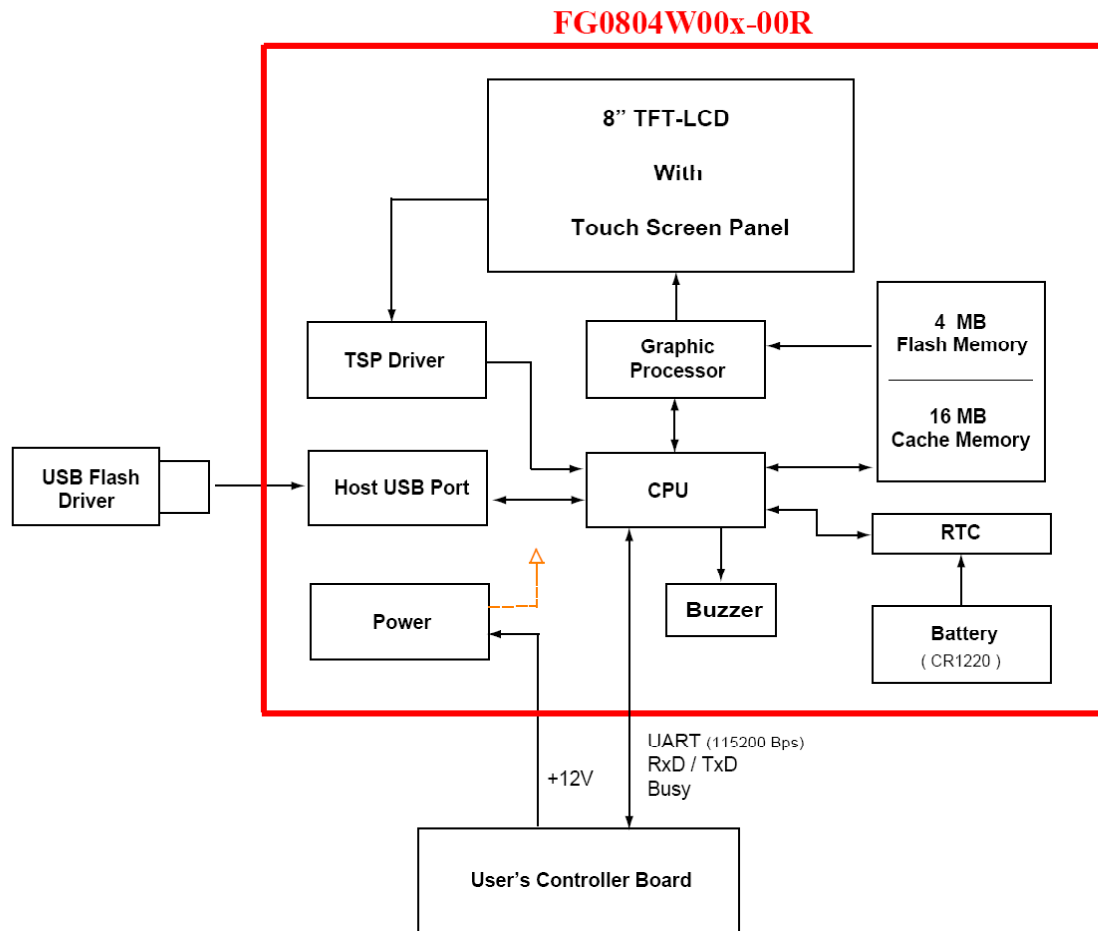

4. Order Information

4.1 Unit

Unit

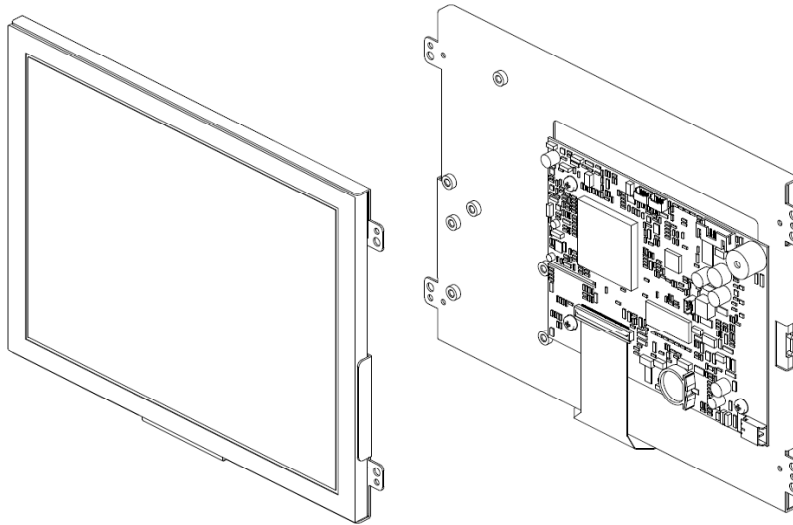

Parameter	FG0804W000-00R	FG0804W001-00R	Unit
RTC	⊙	⊙	
Touch Screen Function	-	4W Resistance	
Buzzer Function	⊙	⊙	

- Note:**
1. The tape in back of the bracket is to avoid the panel falling from the unit in delivery.
 2. It's Just A temporary adhesion.

4.2 Power Cable (Option)

Power Cable



Order Part Number	Pin Description	Remark
LACABLE008-FDR	7P 2.0mm - 4P1.25mm - 5.5mm-DC Jack	

FLAT DISPLAY TECHNOLOGY

■ FG0804W00x-00R V0.0



5. Specifications

Parameter	Specifications	Unit	Remark
Communication Protocol	Duplex Transmission (UART)		
	UART Transmission Rate	115200	Bps
	Data Bit	8	Bits
	Parity Bit Check	NO	
	Stop Bit	1	Bit
USB(TYPE A)	Host	USB 1.1	
Weight	---	g	
Flash ROM	4M	Bytes	Note1
SDRAM	16M	Bytes	
Picture Format	JPEG Category		Note1

NOTE:1 How many pictures in flash memory depend on picture's compression ratio.

6. Absolute Maximum Ratings

6.1 Absolute Maximum Ratings

Parameter	Symbol	Min	Max	Unit	Remark
Input Voltage	V _{in}	+9	+15	V	
Digital Input Signal	TTL	+0.3	+3.6	V	
Operating Temperature Without TSP		-20	+60	°C	
Operating Temperature With TSP		-10	+60	°C	
Storage Temperature Without TSP		-20	+70	°C	
Storage Temperature With TSP		-20	+70	°C	

FLAT DISPLAY TECHNOLOGY

■ FG0804W00x-00R V0.0



7. Recommended Operating Conditions

7.1 Electrical Characteristics

Parameter	Symbol	Min	Typ	Max	Unit	Note
Input Voltage	Vin	+10	+12	+14	V	
Total Current	Iin	-	335	-	mA	@+12V
Power Consumption	-	-	4.02	-	W	@+12V
I/O	TTL	+0.1	-	+3.3	V	

8. TFT-LCD Information

8.1 TFT-LCD Mechanical Specifications

Parameter	Specifications	Unit
Screen Size	8" (Diagonal)	inch
Display Format	800 x (R.G.B) x 600	dot
Active Area	162(W) x 121.5(H)	mm
Surface Treatment	Anti – Glare	

8.2 TFT-LCD Optical Characteristics

Parameter	Symbol	Condition	Min	Typ	Max	Unit	Remark
Viewing Angle	Horizontal	Left	60	70	---	deg	
		Right	60	70	---	deg	
	Vertical	Top	40	50	---	deg	
		Bottom	60	70	---	deg	
Contrast Ratio	CR	At optimized Viewing angle	400	500	---	---	
Brightness Without TSP	L	$\theta = 0^\circ / \phi = 0$	200	250	---	cd/m ²	
Brightness With TSP	L	$\theta = 0^\circ / \phi = 0$	160	200	---	cd/m ²	
LED Life Time	---	T _a =+25°C	20000	---	---	Hrs	I _L =200mA

FLAT DISPLAY TECHNOLOGY

■ FG0804W00x-00R V0.0



9. Pin Description

9.1 J107A Pin Assignment of Signal Input (Pitch 2.0mm 7Pin, Side Entry Type)

※ Connector Part No.: M24267R (STM) or S7B-PH-K-S (JST); Matching Connector Part No.: P24267 (STM) or PHR-7 (JST)

Pin No	Symbol	I/O	Description	Remark
1	VCC12V	-	+12V Input Voltage	DC
2	VCC12V	-	+12V Input Voltage	DC
3	GND	-	Ground	
4	GND	-	Ground	
5	BUSY	O	Busy status (Internal pull high)	High: Busy Low: Normal (Note1)
6	RXD	I	Receive Data (UART)	TTL Level RS-232 (3.3V)
7	TXD	O	Transmit Data (UART)	TTL Level RS-232 (3.3V)

Note1: Your application circuit board must be connects with busy pin of SGM.

9.2 UART Timing Chart (Client side)

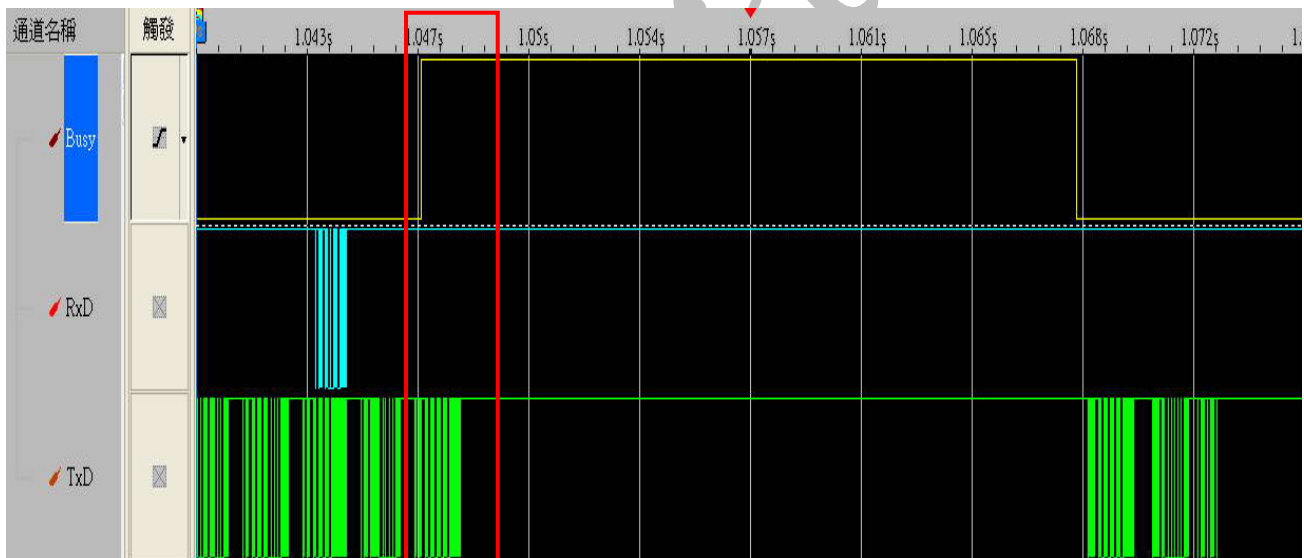

※ If busy signal of SGM appears on the duration of client processor transmission command.
Please don't worry this situation and goes on last command procedure.

10. 4W Resistance Touch Panel Characteristics

10.1 Touch Screen Integration Design Guide

Avoid the design that Front-case overlap and press on the active area of the touch-panel.

Give enough gap (over 0.5mm at compressed) between the front case and touch-panel to protect wrong operating.

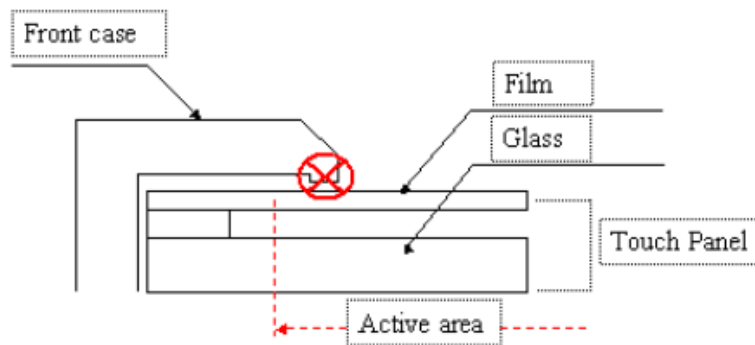

Use a buffer material (Gasket) between the touch-panel and front-case to protect damage and wrong operating.

Avoid the design that buffer material overlap and press on the inside of touch-panel viewing area.

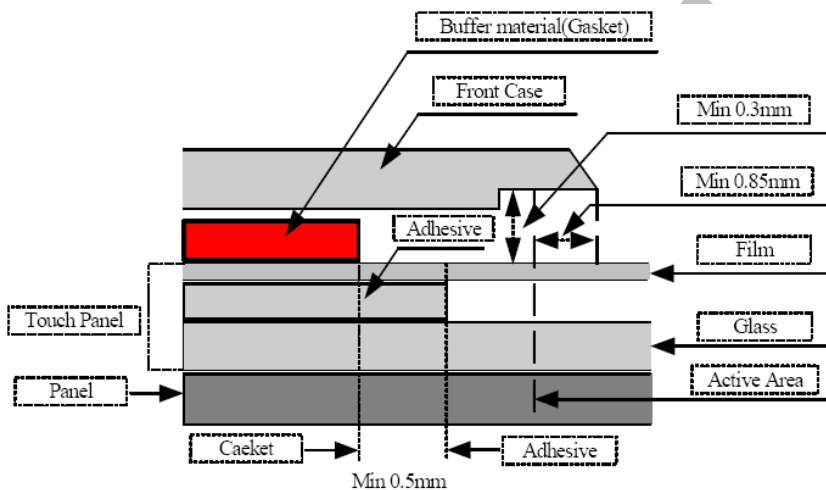

Note: We strongly suggest to follow above design guide to avoid the linear defect happened on the touch panel.

10.2 Mechanical Performance

Parameter	Specifications
Input Method	Finger or stylus pen
Operating Force	Max: 50gf
Surface Hardness	3H or more

10.3 Durability Performance

Parameter	Specifications
Hitting Durability	≥ 1000000 times, with R8.0 mm silicon rubber, 200g, 5Hz
Sliding Durability	≥ 100000 times, with R0.8 mm polyacetal stylus, 250g, 60 mm / sec

FLAT DISPLAY TECHNOLOGY

■ FG0804W00x-00R V0.0



11. Buzzer Notice

11.1 Remove Buzzer Label

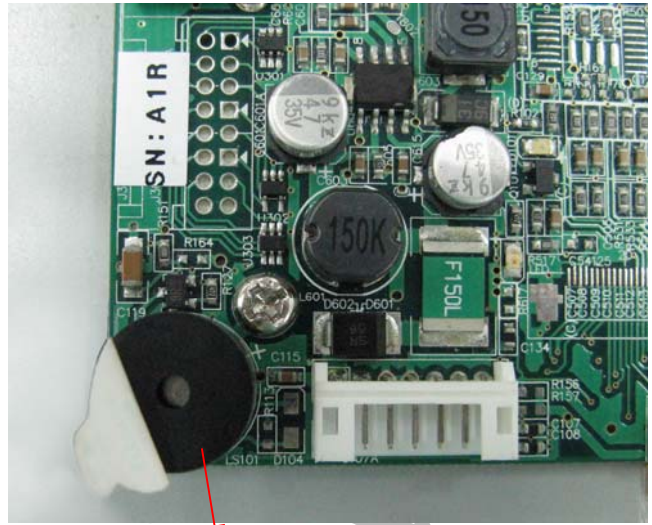
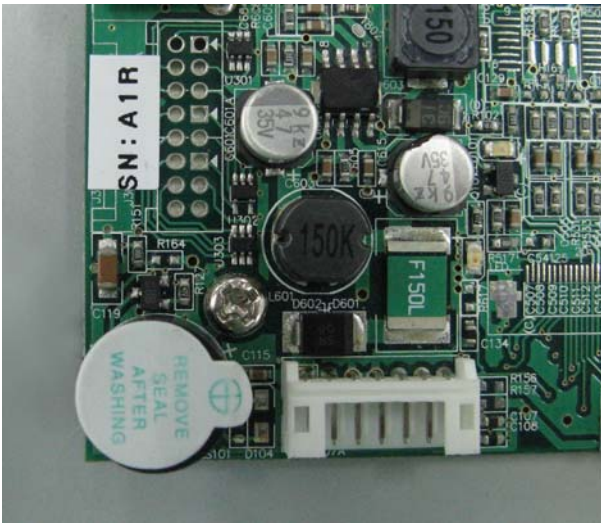

Remove

Tentati

12. Dimension Information

12.1 Unit (FG0804W000-00R)

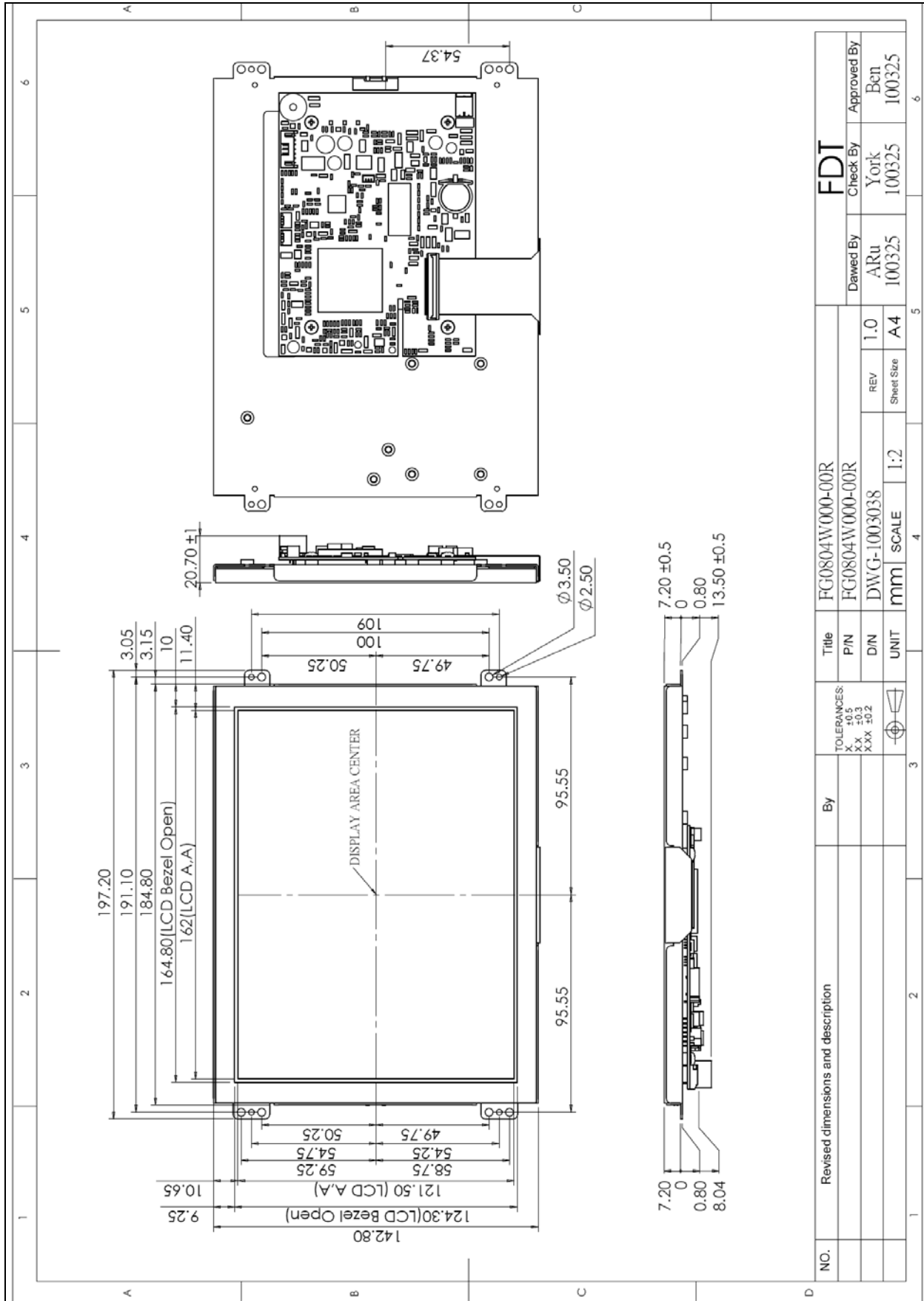

FLAT DISPLAY TECHNOLOGY

FG0804W000-00R V0.0



12.2 Unit (FG0804W000-00R-2)

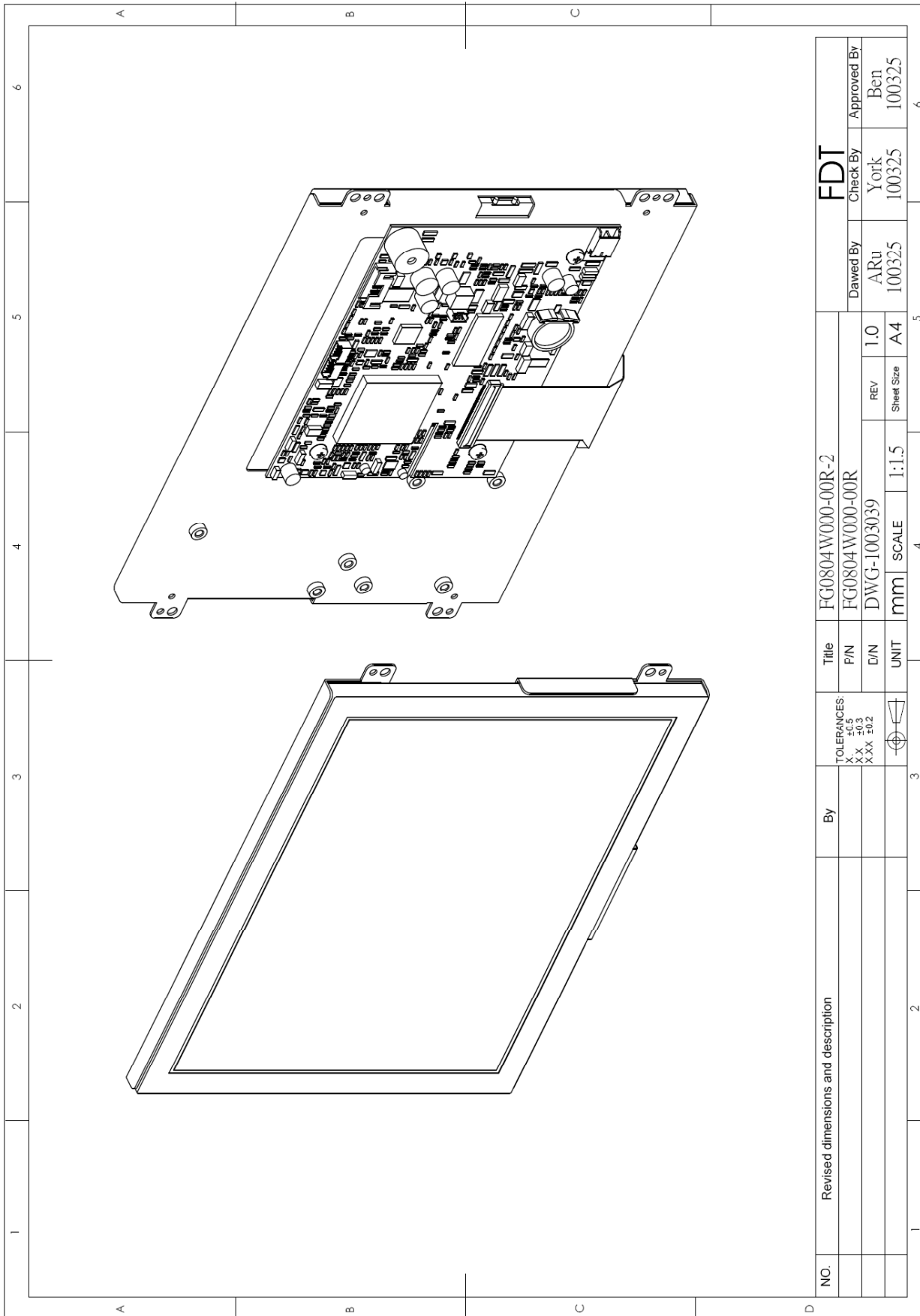

NO.	Revised dimensions and description	By	TOLERANCES: X ±0.5 XX ±0.3 XXX ±0.2	UNIT	SCALE	REV	Sheet Size	Drawn By	Check By	Approved By	FDT	
				mm	1:1.5	1.0	A4	ARu	York	Ben	100325	100325
								100325	100325	100325		

12.3 Unit (FG0804W001-00R)

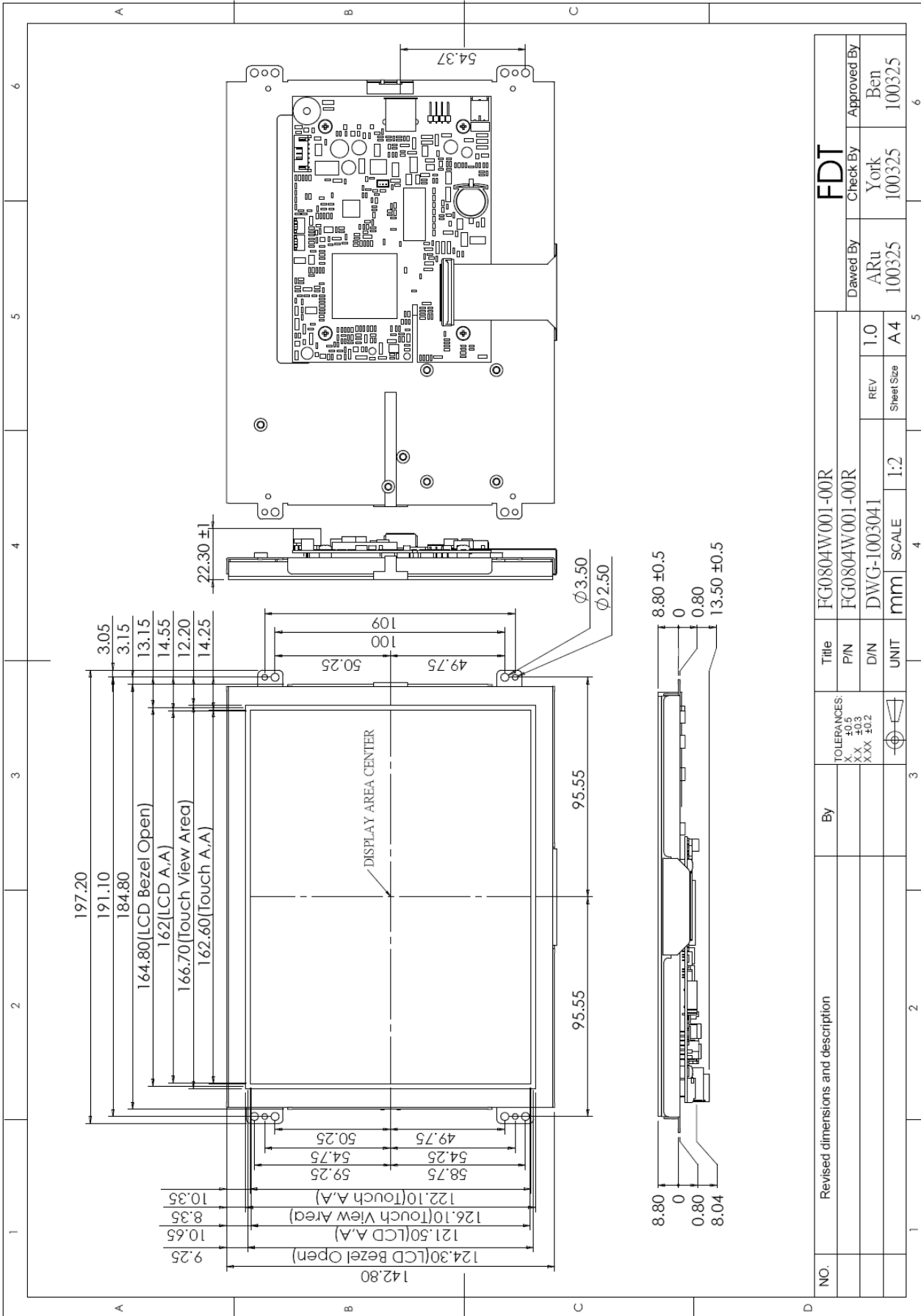

12.4 Unit (FG0804W001-00R-2)

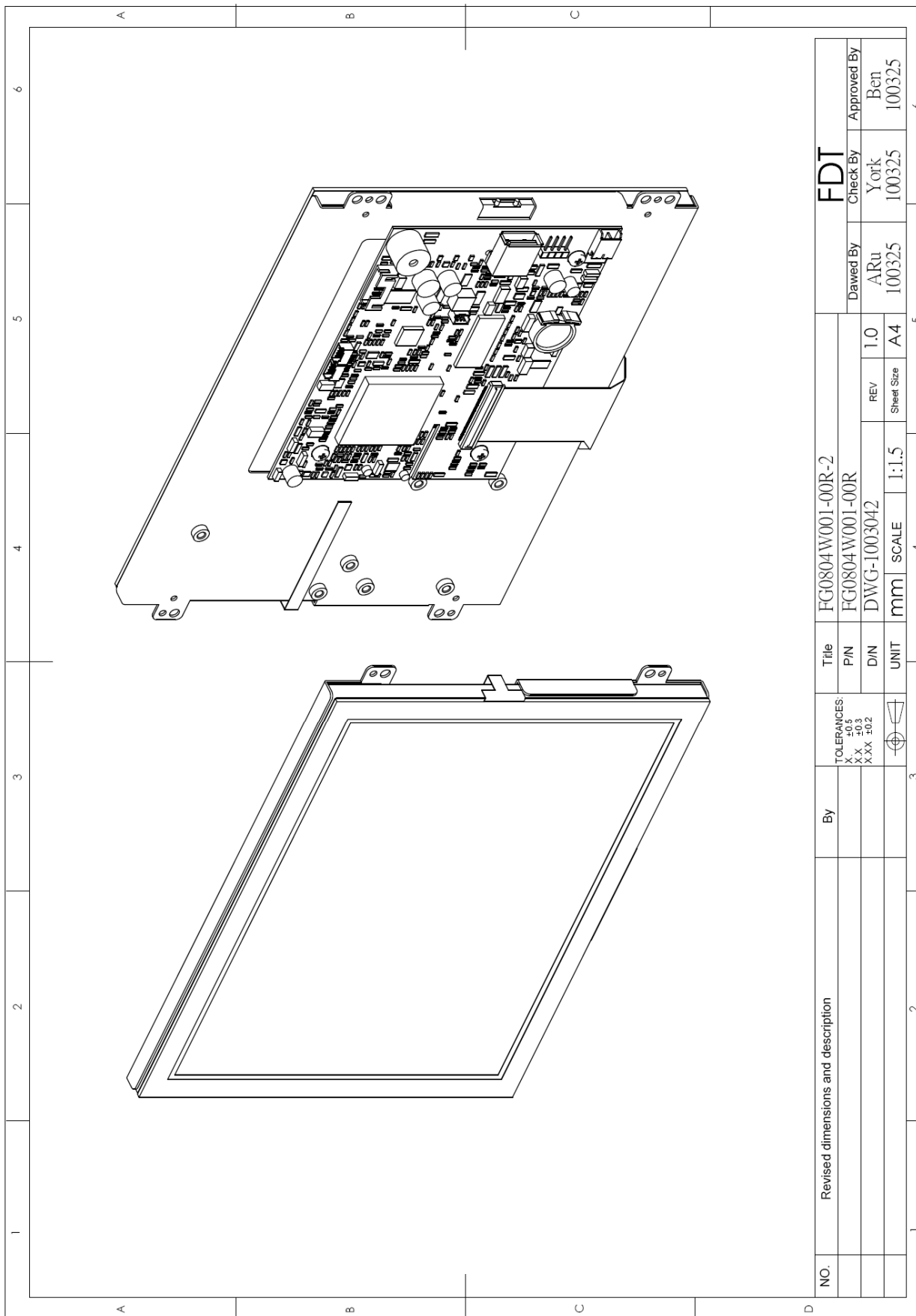

NO.	Revised dimensions and description	By	TOLERANCES: X ±0.5 XX ±0.3 XXX ±0.2	Title		Dated By		Check By		Approved By	
				P/N	FG0804W001-00R	ARu	York	Ben			
				D/N	DWG-1003042	REV	1.0	100325	100325		
			UNIT	mm	SCALE	1:1.5	Sheet Size	A4			

FDT



13. Accessory

13.1 LACABLE008-FDR (Option)

