



§ **SPECIFICATION APPROVAL SHEET** §

**Fdt Tech Module No**      **FG102WW00~~x~~-00R**

**Description:**            **10.2" Digital TFT-LCD Module**

**SPEC No.:**                **SAS-0912004**

**Version:**                 **0.0**

**Issue Date:**             **January 4, 2011**

※ This approval sheet contains 15 pages including the cover and appendix.

**Customer:**

**APPROVED BY:**

**Date:**      /      / 11

**APPROVED BY:**

**CHECKED BY:**

**DESIGNED BY:**

\_\_\_\_\_

\_\_\_\_\_

\_\_\_\_\_



# FLAT DISPLAY TECHNOLOGY

## 10.2" GRAPHIC TFT-LCD Module

- FG102WW000-00R
- FG102WW001-00R

### 1. General Description

FDT Smart Graphic TFT Module is a unique TFT LCD module which builds graphic and character inside. It provides user to present customized & full color graphics or characters without any SOC or IPC system. In addition, user can update or upload his graphics or characters via USB port by himself. FDT Smart Graphic TFT Module not only enhances your product values also saves your cost.



#### 1.1 Features

- Single Operation Voltage +12V
- Full Colors Presentation
- UART Interface For Communication
- Easy To Set Up Without SOC or IPC Controller
- Built In Real Time Clock
- Buzzer Function
- LED Backlight Brightness Control
- Touch Screen Function (Option)
- USB Port For Update Graphic Library

#### 1.2 Application

- Industrial Controller
- Medical Equipment
- Security Equipment
- Simple Function Equipment

FLAT DISPLAY TECHNOLOGY

■ FG102WW00x-00R V0.0



## 2. Contents

Contents	Page
<b>1. General Description</b> .....	1
1.1 Features	1
1.2 Applications	1
<b>2. Contents</b> .....	2
<b>3. Block Diagram</b> .....	3
3.1 Block Diagram	3
<b>4. Order Information</b> .....	4
4.1 Unit	4
4.2 Power Cable (Option)	4
<b>5. Specifications</b> .....	5
<b>6. Absolute Maximum Ratings</b> .....	5
6.1 Absolute Maximum Ratings	5
<b>7. Recommended operating conditions</b> .....	6
7.1 Electrical Characteristics	6
<b>8. TFT-LCD Information</b> .....	6
8.1 TFT-LCD Mechanical Specifications	6
8.2 TFT-LCD Optical Characteristics	6
<b>9. Pin Description</b> .....	7
9.1 J207B Assignment of Signal Input(Pitch 2.0mm 7Pin,Side Entry Type)	7
9.2 UART Timing Chart( Client side )	7
<b>10. 4W Resistance Touch Panel Characteristics</b> .....	8
10.1 Touch Screen Integration Design Guide	8
10.2 Mechanical Performance	8
10.3 Durability Performance	8
<b>11. Buzzer Notice</b> .....	9
11.1 Remove Buzzer Label	9
<b>12.Dimension Information</b> .....	10-13
12.1Unit(FG102WW000-00R)	10
12.2Unit(FG102WW000-00R-2)	11
12.3Unit(FG102WW001-00R)	12
12.4Unit(FG102WW001-00R-2)	13
<b>13. Accessory</b> .....	14
13.1 LACABLE008-FDR (Option)	14



**3. Block Diagram**  
**3.1 Block Diagram**

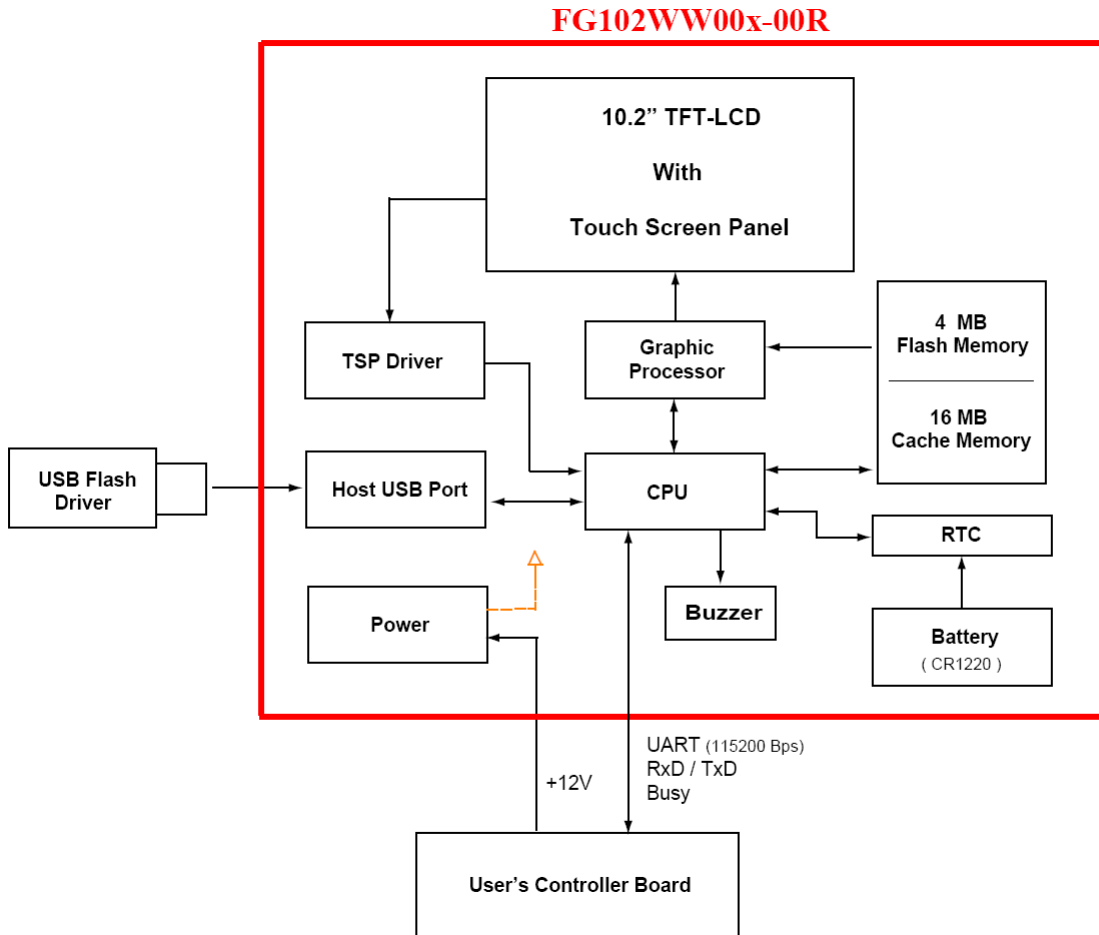

TELE



## 4. Order Information

### 4.1 Unit

#### Unit

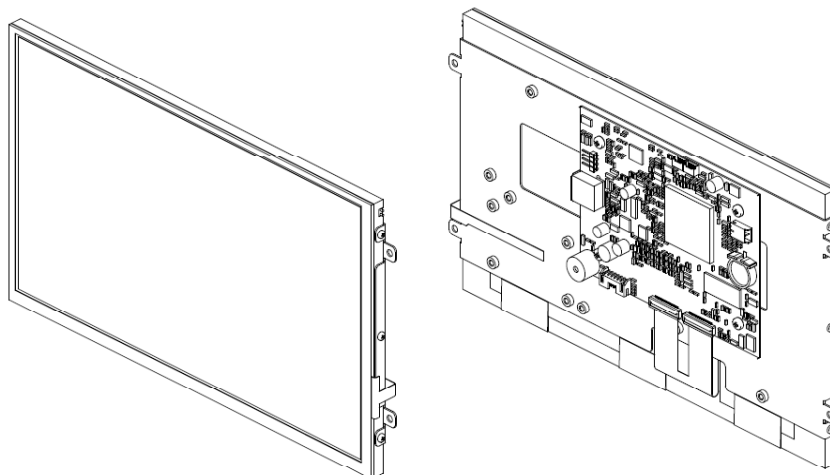

Parameter	FG102WW000-00R	FG102WW001-00R	Unit
RTC	⊙	⊙	
Touch Screen Function	-	4W Resistance	
Buzzer Function	⊙	⊙	

Note:1.The tape in back of the bracket is to avoid the panel falling from the unit in delivery.  
2.It's Just A temporary adhesion.

### 4.2 Power Cable (Option)

#### Power Cable



Order Part Number	Pin Description	Remark
LACABLE008-FDR	7P 2.0mm - 4P1.25mm - 5.5mm-DC Jack	

**FLAT DISPLAY TECHNOLOGY**

■ FG102WW00x-00R V0.0



## 5. Specifications

Parameter	Specifications	Unit	Remark	
Communication Protocol	Duplex Transmission (UART)			
	UART Transmission Rate	115200	Bps	
	Data Bit	8	Bits	
	Parity Bit Check	NO		
	Stop Bit	1	Bit	
USB (TYPE A)	Host	USB 1.1		
Weight	---	g		
Flash ROM	4M	Bytes	Note1	
SDRAM	16M	Bytes		
Picture Format	JPEG Category		Note1	

**NOTE:1** How many pictures in flash memory depend on picture's compression ratio.

## 6. Absolute Maximum Ratings

### 6.1 Absolute Maximum Ratings

Parameter	Symbol	Min	Max	Unit	Remark
Input Voltage	V <sub>in</sub>	+9	+15	V	
Digital Input Signal	TTL	+0.3	+3.6	V	
Operating Temperature Without TSP		-20	+70	°C	
Operating Temperature With TSP		-10	+60	°C	
Storage Temperature Without TSP		-20	+70	°C	
Storage Temperature With TSP		-20	+70	°C	

**FLAT DISPLAY TECHNOLOGY**

■ FG102WW00x-00R V0.0



## 7. Recommended Operating Conditions

### 7.1 Electrical Characteristics

Parameter	Symbol	Min	Typ	Max	Unit	Note
Input Voltage	Vin	+10	+12	+14	V	
Total Current	Lin	-	360	-	mA	
Power Consumption		-	4.32	-	W	
I/O	TTL	+0.1	-	+3.3	V	

## 8. TFT-LCD Information

### 8.1 TFT-LCD Mechanical Specifications

Parameter	Specifications	Unit
Screen Size	10.2 (diagonal)	inch
Display Format	800 x (R.G.B) x 480	dot
Active Area	222.0(H) x 132.48(V)	mm
Surface Treatment	Anti-glare	

### 8.2 TFT-LCD Optical Characteristics

Parameter	Symbol	Condition	Min	Typ	Max	Unit	Remark
Viewing Angle	Horizontal	Left	55	65	---	deg	
		Right	55	65	---		
	Vertical	Top	35	45	---	deg	
		Bottom	55	65	---	deg	
Contrast Ratio	CR	At Optimized Viewing Angle	250	300	---	---	
Brightness Without TSP	L	$\theta = 0^\circ / \phi = 0$	280	350	---	cd/m <sup>2</sup>	
Brightness With TSP	L	$\theta = 0^\circ / \phi = 0$	224	280	---	cd/m <sup>2</sup>	
LED Life Time	---	T <sub>a</sub> =25°C	20000	---	---	Hr	

## 9. Pin Description

### 9.1 J207B Pin Assignment of Signal Input (Pitch 2.0mm 7Pin, Side Entry Type)

※ Connector Part No.: M24267R (STM) or S7B-PH-K-S (JST); Matching Connector Part No.: P24267 (STM) or PHR-7 (JST)

Pin No	Symbol	I/O	Description	Remark
1	VCC12V	-	+12V Input Voltage	DC
2	VCC12V	-	+12V Input Voltage	DC
3	GND	-	Ground	
4	GND	-	Ground	
5	BUSY	O	Busy status (Internal pull high)	High: Busy Low: Normal (Note1)
6	RXD	I	Receive Data (UART)	TTL Level RS-232 (3.3V)
7	TXD	O	Transmit Data (UART)	TTL Level RS-232 (3.3V)

**Note1:** Your application circuit board must be connects with busy pin of SGM.

### 9.2 UART Timing Chart ( Client side )

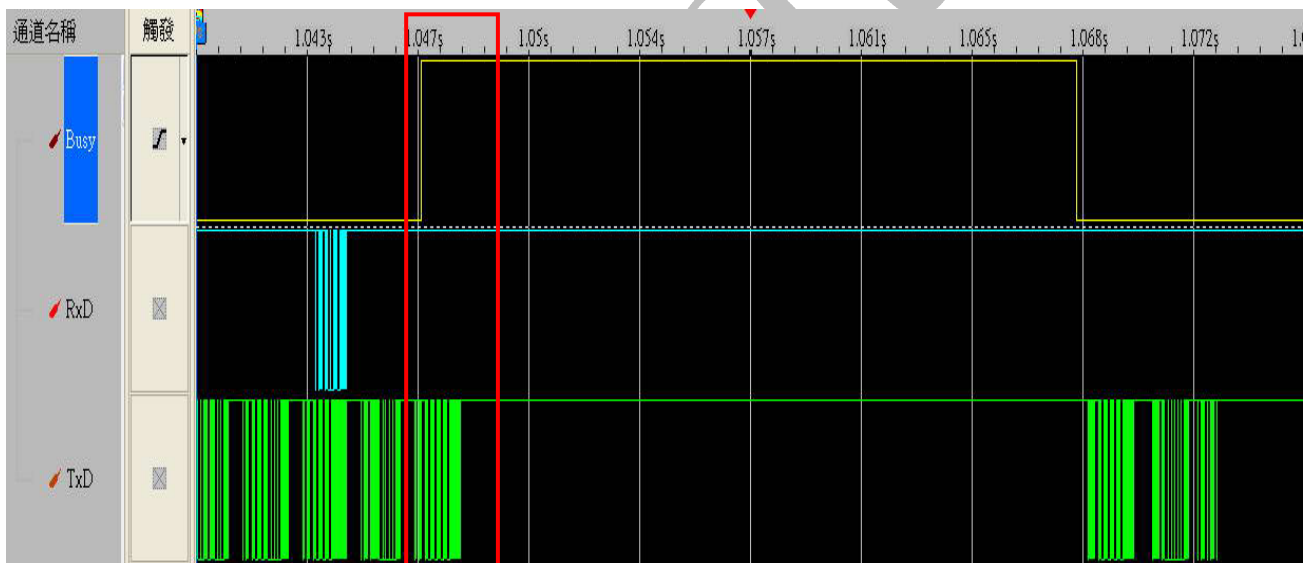

※ If busy signal of SGM appears on the duration of client processor transmission command.  
Please don't worry this situation and goes on last command procedure.



## 10. 4W Resistance Touch Panel Characteristics

### 10.1 Touch Screen Integration Design Guide

Avoid the design that Front-case overlap and press on the active area of the touch-panel.

Give enough gap (over 0.5mm at compressed) between the front case and touch-panel to protect wrong operating.

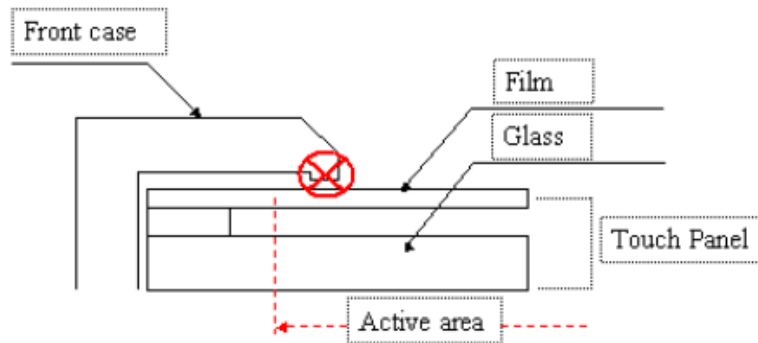

Use a buffer material (Gasket) between the touch-panel and front-case to protect damage and wrong operating.

Avoid the design that buffer material overlap and press on the inside of touch-panel viewing area.

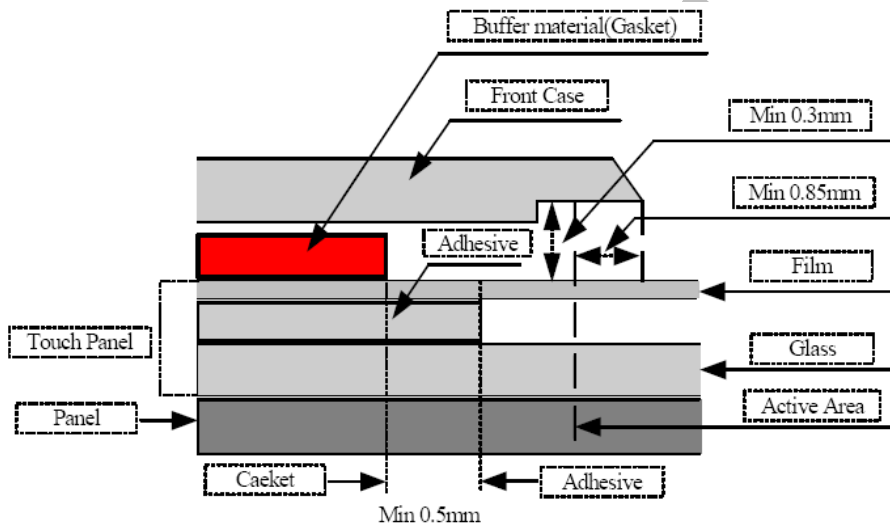

**Note: We strongly suggest to follow above design guide to avoid the linear defect happened on the touch panel.**

### 10.2 Mechanical Performance

Parameter	Specifications
<b>Input Method</b>	Finger or stylus pen
<b>Operating Force</b>	Max: 150gf
<b>Surface Hardness</b>	3H or more

### 10.3 Durability Performance

Parameter	Specifications
<b>Pen Sliding Durability</b>	$\geq 100000$ words, with R0.8 mm polyacetal stylus, 250g, 60 mm / sec
<b>Sliding Durability</b>	$\geq 1000000$ words, with R8.0 mm silicon rubber, 200g, 5Hz

**FLAT DISPLAY TECHNOLOGY**

■ FG102WW00x-00R V0.0



## 11. Buzzer Notice

### 11.1 Remove Buzzer Label

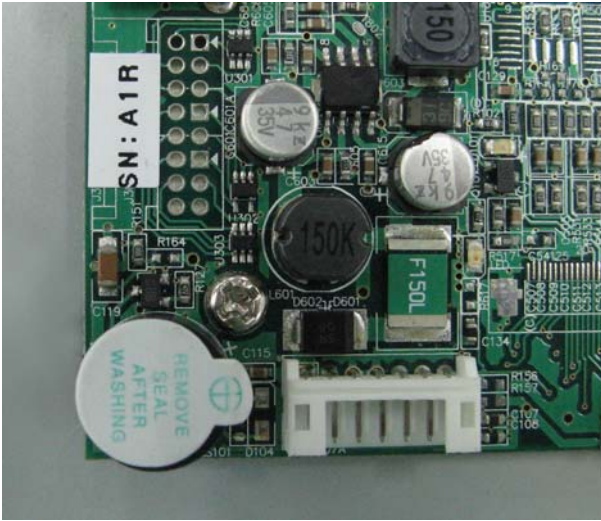

Remove

Tentati



# 12. Dimension Information

## 12.1 Unit (FG102WW000-00R)

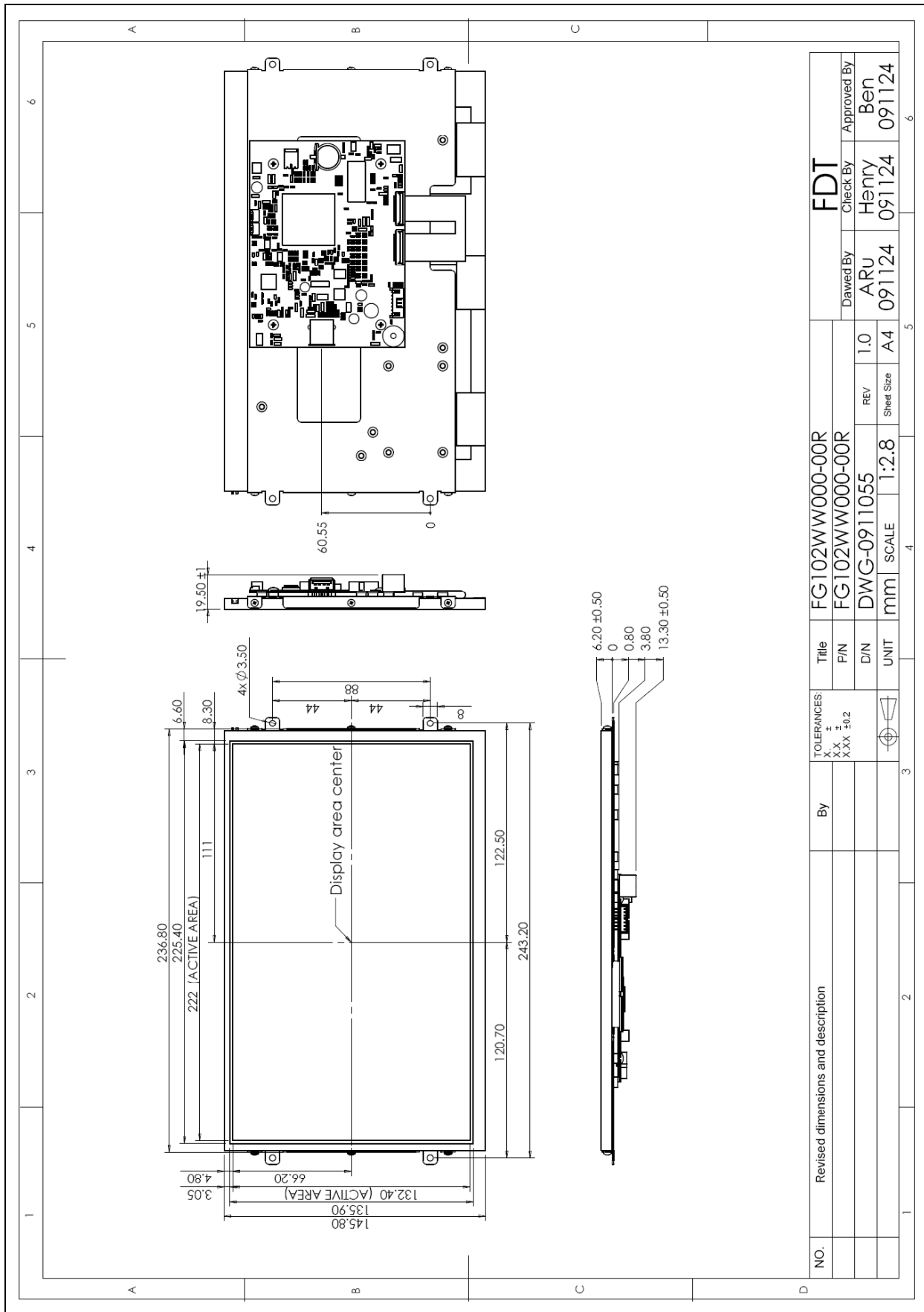

**12.2 Unit (FG102WW000-00R-2)**

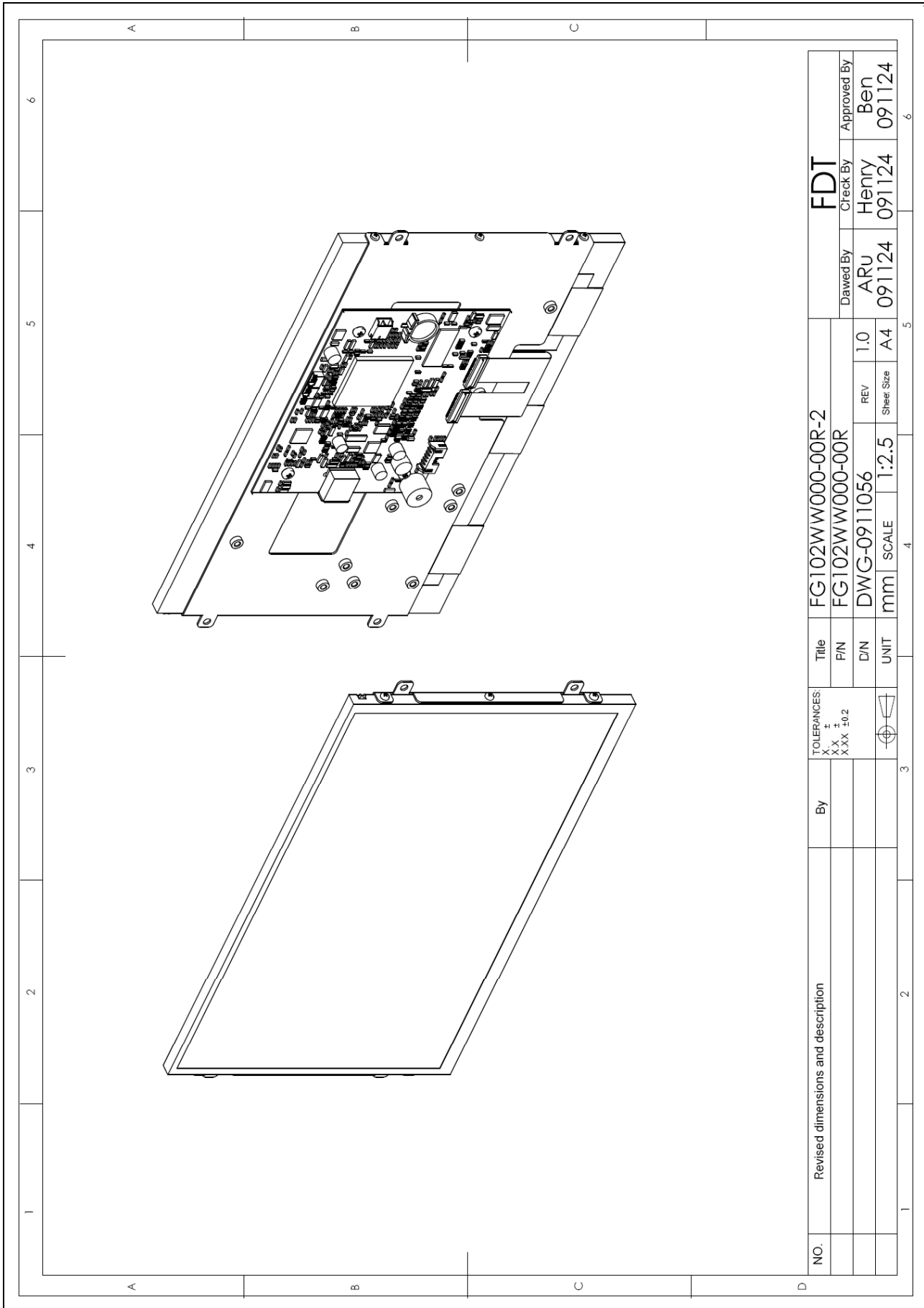

**FLAT DISPLAY TECHNOLOGY**

■ FG102WW00x-00R V0.0



**12.3 Unit (FG102WW001-00R)**

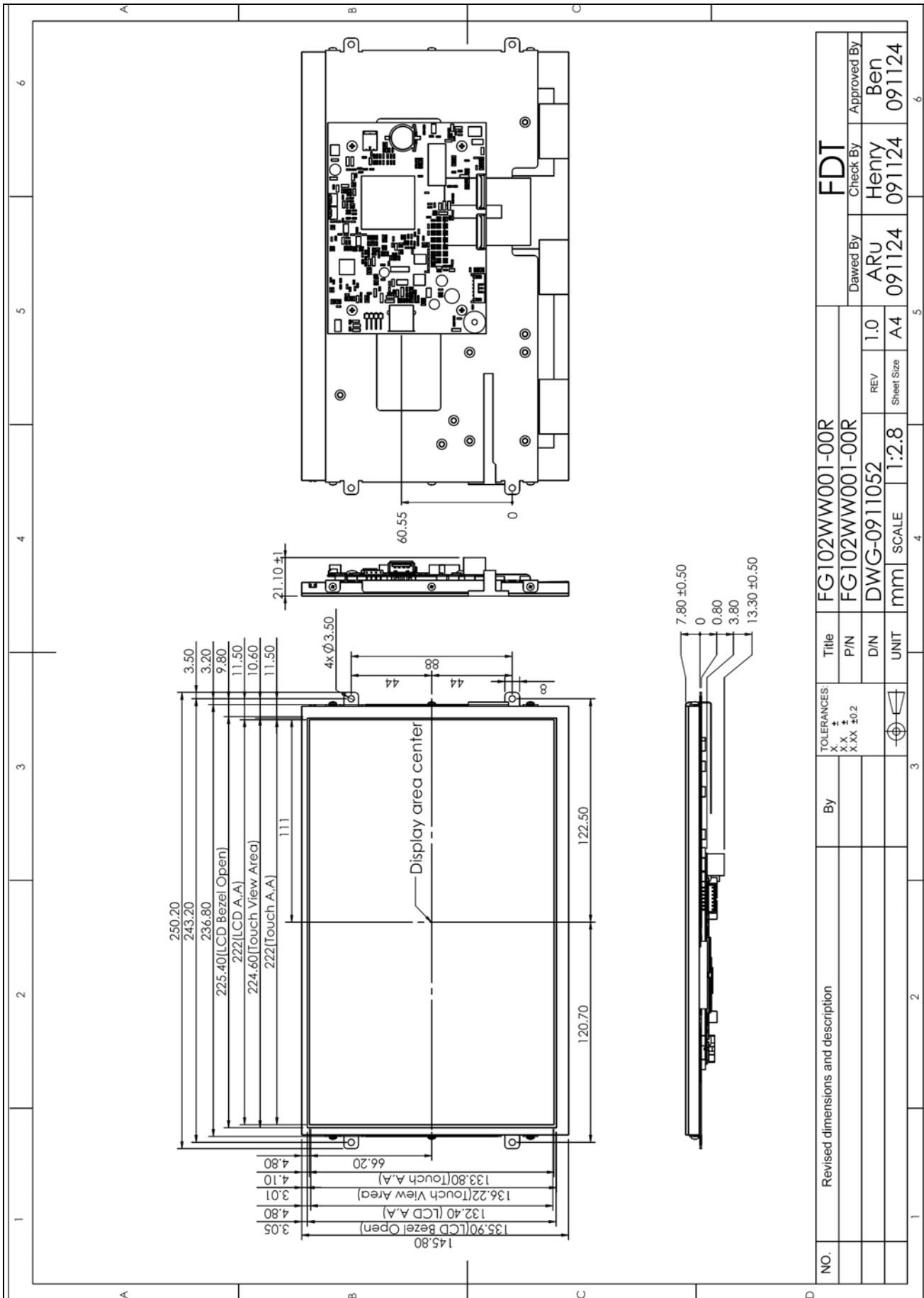

**FLAT DISPLAY TECHNOLOGY**

■ FG102WW001-00R V0.0



**12.4 Unit (FG102WW001-00R-2)**

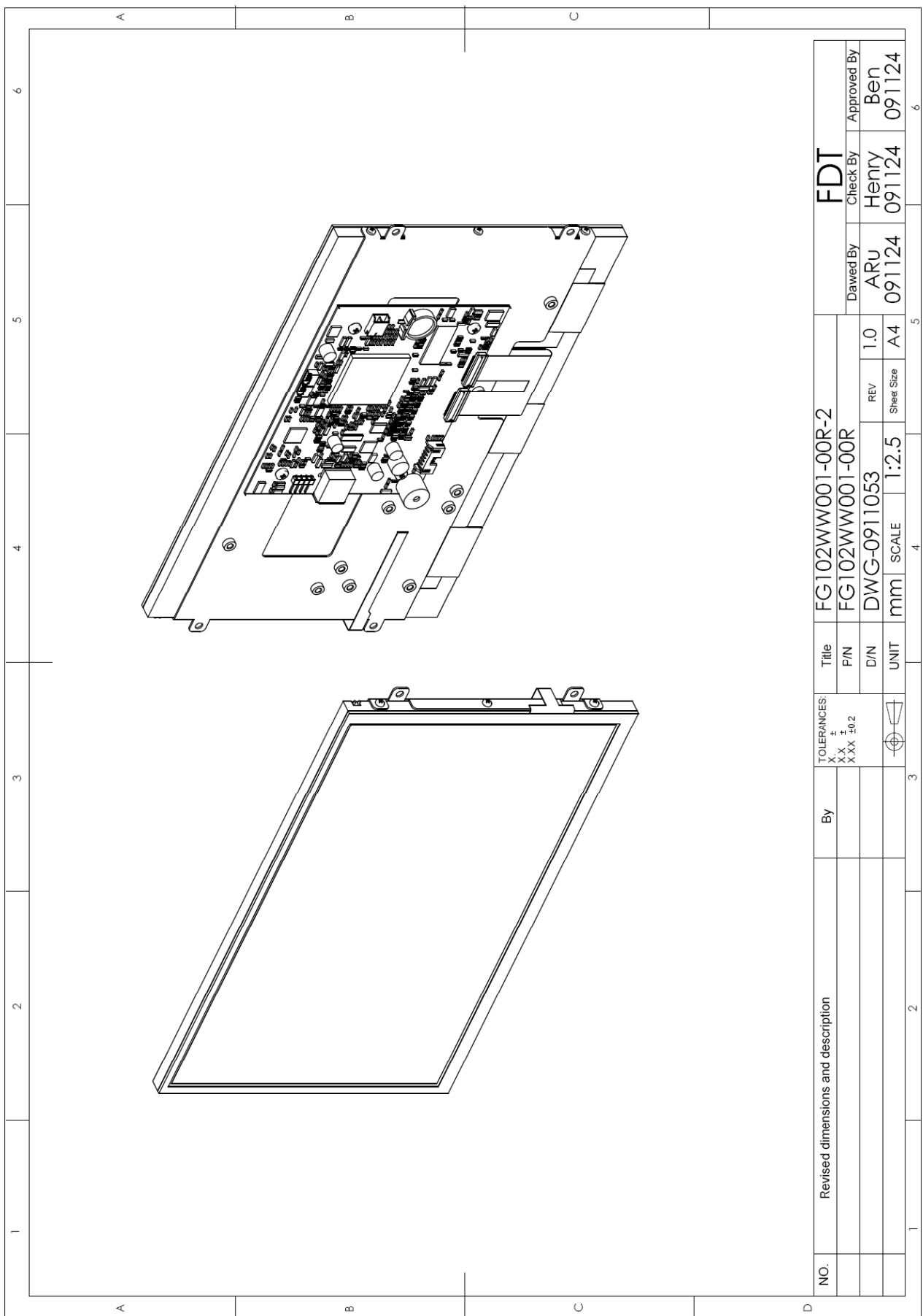

NO.	Revised dimensions and description	By	TOLERANCES: X ± X.X ± X.XX ±0.2	Title	FG102WW001-00R-2	FDT	
				P/N	FG102WW001-00R	Drafted By	Check By
				D/N	DWG-0911053	ARU	Henry
				UNIT	mm	091124	091124
				SCALE	1:2.5	REV	1.0
						Sheet Size	A4
						Approved By	Ben
							091124

**FLAT DISPLAY TECHNOLOGY**

■ FG102WW00x-00R V0.0 

# 13. Accessory

## 13.1 LACABLE008-FDR (Option)

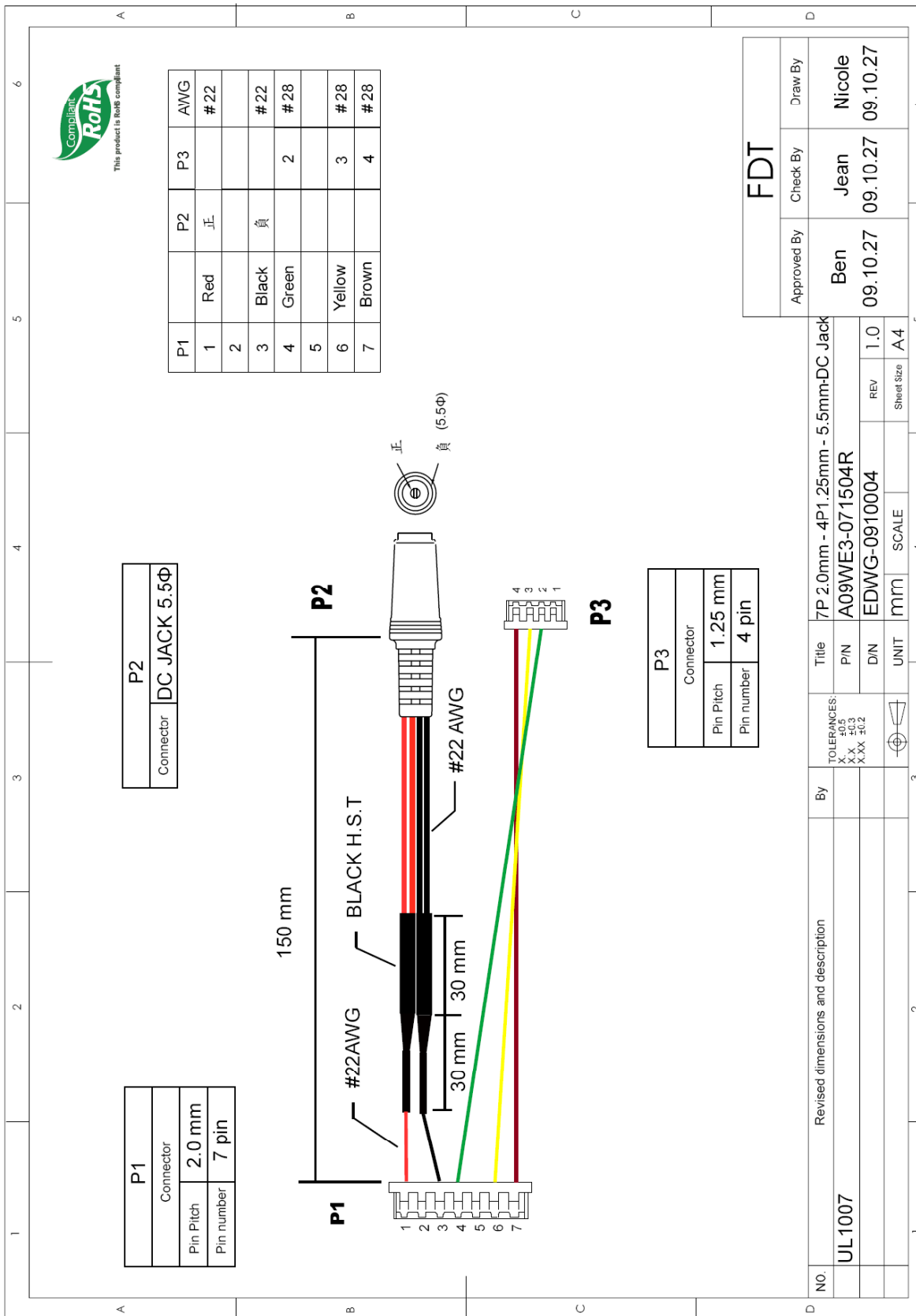

FLAT DISPLAY TECHNOLOGY

FG102WW00X-00R V0.0

