



§ SPECIFICATION APPROVAL SHEET §

Fdt Tech Module No LP104CWWB~~x~~-F~~x~~R

Description: 10.4" Digital TFT-LCD Module

SPEC No.: SAS-1212002

Version: 0.1

Issue Date: October 18, 2013

※ This approval sheet contains 23 pages including the cover and appendix.

Customer:

Date: / / 13

APPROVED BY:

APPROVED BY:

CHECKED BY:

DESIGNED BY:



FLAT DISPLAY TECHNOLOGY

10.4" Digital TFT-LCD Module

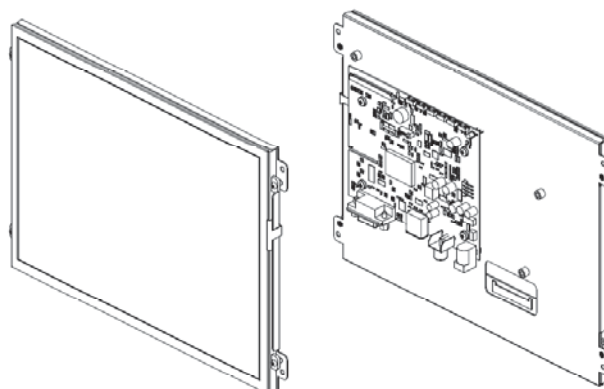

■ LP104CWWB~~x~~-F~~x~~R

1. General Description

1.1 Features

- 10.4" Digital TFT LCD
- Ultra Compact
- NTSC/PAL/SECAM Video Auto Switch
- Single Operation Voltage +12V
- CVBS / Analog RGB (PC Mode) Signal Input
- All Functions can be controlled by UART
- Support Touch Screen Function (Option)

1.2 Applications

- Portable product
- Industrial
- Hand-held
- Security
- Instrument Display
- Office Electronics

1.3 Application Precautions

Do not use the products herein for the following equipment which demands extremely high performance in terms of functionality, reliability, or accuracy.

- Aerospace equipment
- Communication equipment for trunk lines.
- Control equipment for the nuclear power industry.
- Medical equipment related to life support, etc.

The other application that demands high reliability and functionality should first contact a sales representative.

FLAT DISPLAY TECHNOLOGY

■ LP104CWWB~~x~~-F~~x~~R V0.1



2. Contents

Contents	Page
1. General Description	1
1.1 Features	1
1.2 Applications	1
1.3 Application Precautions	1
2. Contents	2-3
3. Block Diagram	4
3.1 Block Diagram	4
4. TFT-LCD Information	5
4.1 TFT-LCD Mechanical Specifications	5
4.2 TFT-LCD Optical Characteristics	5
5. Order Information	6-7
5.1 Unit	6
5.1 Unit (Touch)	7
6. Dimension Information	8-10
6.1 Unit (LP104CWVB1-FNR)	8
6.2 Unit (LP104CWVB4-FNR)	9
6.3 Unit (LP104CWVB5-FNR)	10
7. Pin Description	11-13
7.1 J301 : CPT LCD Panel I/O Terminals (Pitch 1.0mm 30Pin, Side Entry Type)	11
7.2 J106B : Pin Assignment of Analog RGB Input (D-Sub 15Pin)	12
7.3 J104: Pin Assignment of UART (Pitch 1.25mm 4Pin, Top Entry Type)	13
7.4 DC 101: Pin Assignment of Power Input (Inside Diameter:2.1 ϕ Outside Diameter:5.5 ϕ Side Entry Type)	13
7.5 RCA 101: Pin Assignment of Video Input (RCA JACK Yellow, Side Entry Type)	13
7.6 J404 : Pin Assignment of Touch USB (USBA-Female 2.0mm, Side Entry Type)(Option)	13
7.7 DB401 : Pin Assignment of Touch RS232 (D-SUB 9 FEMALE)(Option)	13
8. Absolute Maximum Ratings	14
8.1 Absolute Maximum Ratings	14
9. Recommended operating conditions	14
9.1 Electrical Characteristics	14
9.2 VGA Mode Characteristics	14
10. 4W Resistance Touch Panel Characteristics	15
10.1 Pin assignment	15
10.2 Electrical Performance	15
10.3 Optical Performance	15
10.4 Mechanical Performance	15
10.5 Durability Performance	15
10.6 Mechanical Design Notice For Touch Panel	16

11. Operation Manual.....	17
11.1 Driver Board Manual	17
12. Packing List.....	18
13. Key Function by OSD.....	19-22
13.1 Menu Operation	19-21
13.2 Operations	22

Preliminary

3. Block Diagram

3.1 Block Diagram

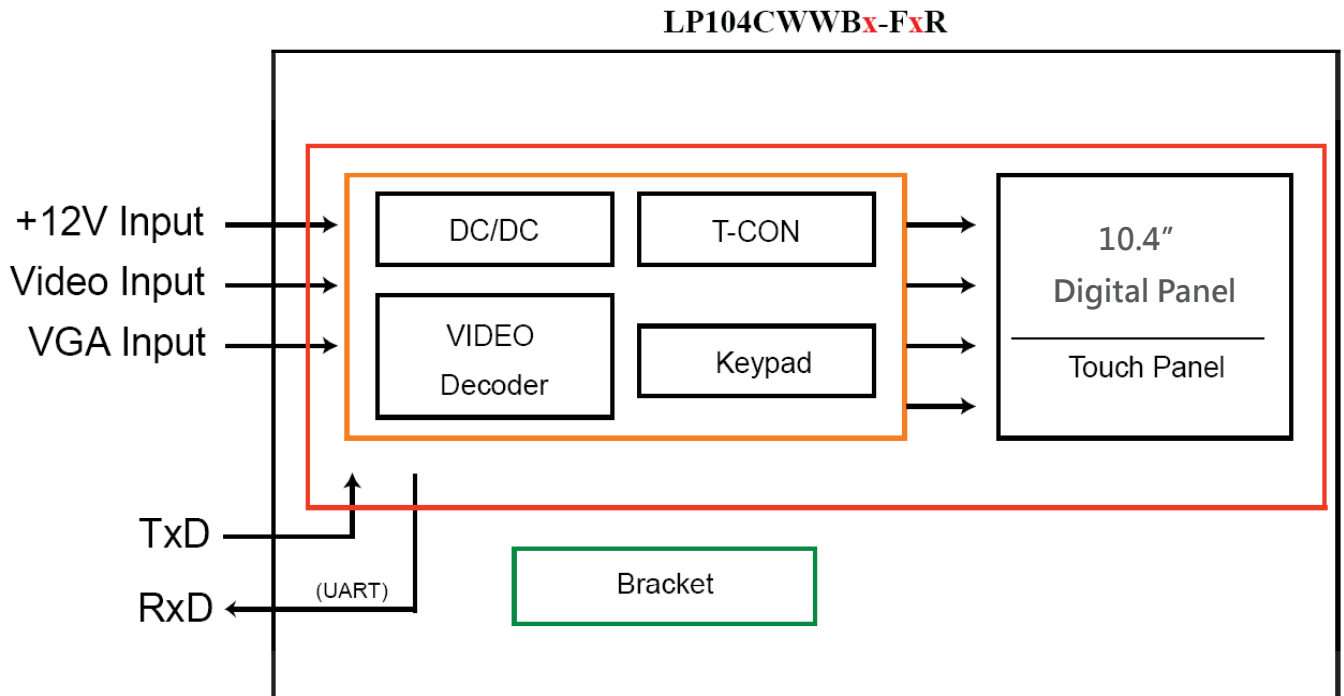

Preliminary

4. TFT-LCD Information

4.1 TFT-LCD Mechanical Specifications

Parameter	Specifications	Unit
Screen Size	10.4 (diagonal)	inch
Display Format	1024 x (R.G.B) x 768	dot
Active Area	211.2 (H) x 158.4 (V)	mm
Pixel Pitch	0.20625 (H) x 0.20625 (V)	mm
Pixel Arrangement	RGB vertical stripe	
Number of colors	262,144	
Surface Treatment	Anti-Glare Hardness: 3H	

4.2 TFT-LCD Optical Characteristics

Parameter	Symbol	Condition	Min	Typ	Max	Unit	Remark
Viewing Angle	Horizontal	Left	65	75	---	deg	
		Right	65	75	---		
	Vertical	Top	50	60	---	deg	
		Bottom	70	80	---	deg	
Contrast Ratio	CR	At optimized Viewing angle			---	---	
Response time	Rise Fall	Tr + Tf	$\theta = 0^\circ$	25	30	ms	
Brightness	L		320	400	---	cd/m ²	
White Chromaticity	x	$\theta = 0^\circ$	0.273	0.313	0.353		
	y	$\theta = 0^\circ$	0.289	0.329	0.369		
LED Life Time		25°C	20000	---	---	Hr	

5. Order Information

5.1 Unit

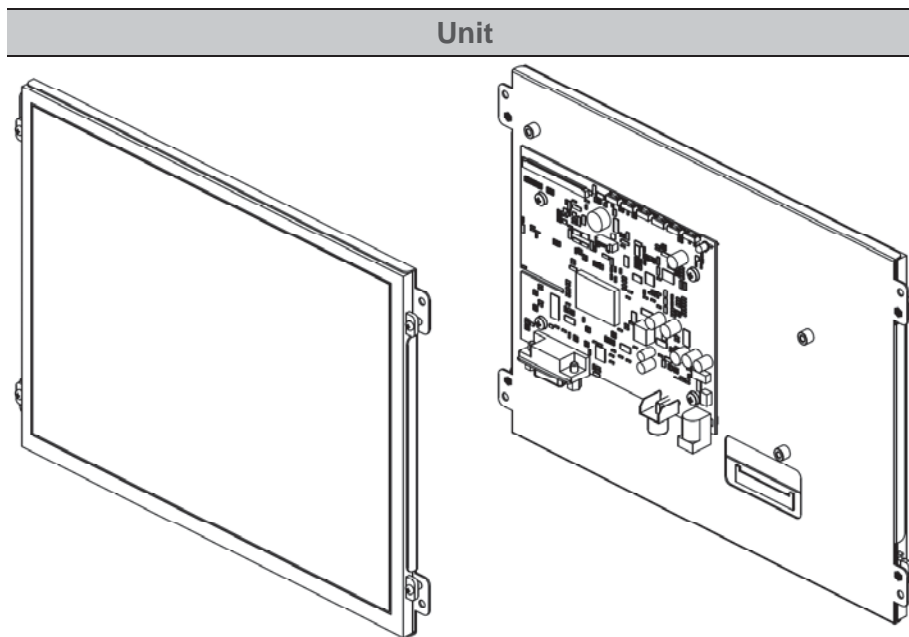

Parameter	LP104CWWB1-FBR	LP104CWWB1-FNR	Unit
CVBS	1	1	
VGA (D-Sub15 / 2.0mm 14Pin)	D-Sub15	D-Sub15	
LVDS Cable 30P-30P 1.0mm L: 200mm	⊙	⊙	
AC to DC Adapter 12V/3A (LASTD12030-FDR)	⊙	-	
Power Cord Plug Type B for USA (LAACD18000-FDR)	⊙	-	
Video Cable (LAVDO18000-FDR)	⊙	-	
VGA Cable (LAVGA16000-FDR)	⊙	-	

FLAT DISPLAY TECHNOLOGY

■ LP104CWWB_x-F_xR V0.1



5.2 Unit (Touch)

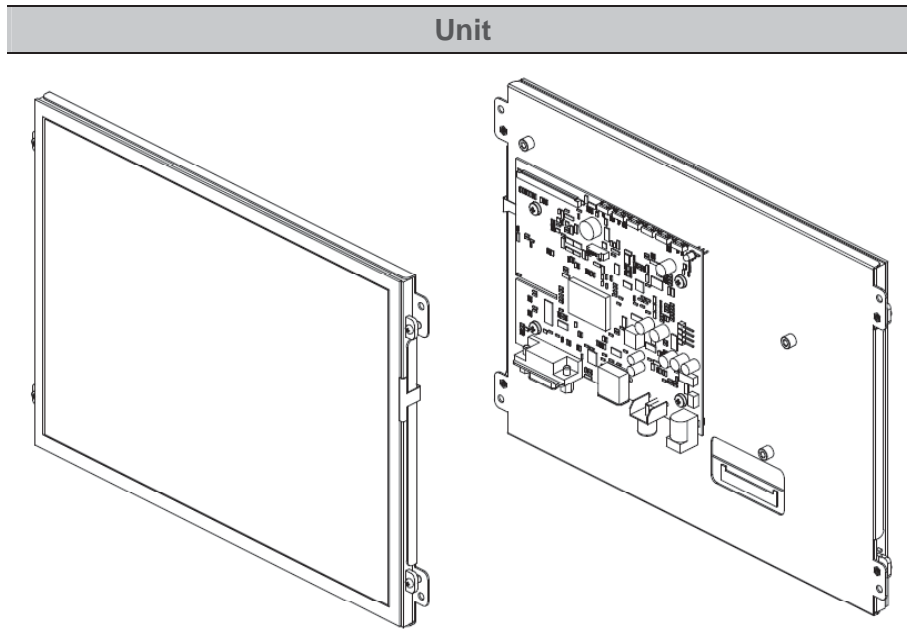

Parameter	LP104CWWB4-FBR	LP104CWWB5-FBR	LP104CWWB4-FNR	LP104CWWB5-FNR	Unit
CVBS	1	1	1	1	
VGA (D-Sub15 / 2.0mm 14Pin)	D-Sub15	D-Sub15	D-Sub15	D-Sub15	
Touch Panel Type	4W Resistive	4W Resistive	4W Resistive	4W Resistive	
Touch Screen Interface	USB	RS232	USB	RS232	
LVDS Cable 30P-30P 1.0mm L: 200mm	⊙	⊙	⊙	⊙	
AC to DC Adapter 12V/3A (LASTD12030-FDR)	⊙	⊙	-	-	
Power Cord Plug Type B for USA (LAACD18000-FDR)	⊙	⊙	-	-	
Video Cable (LAVDO18000-FDR)	⊙	⊙	-	-	
VGA Cable (LAVGA16000-FDR)	⊙	⊙	-	-	
USB Cable (LAUSB18000-FDR)	⊙	-	-	-	
RS-232 Cable (LARS218000-FDR)	-	⊙	-	-	
Touch Screen Driver CD Disk	⊙	⊙	⊙	⊙	

FLAT DISPLAY TECHNOLOGY

■ LP104CWWB_x-F_xR V0.1



6. Dimension Information

6.1 Unit (LP104CWWB1-FNR)

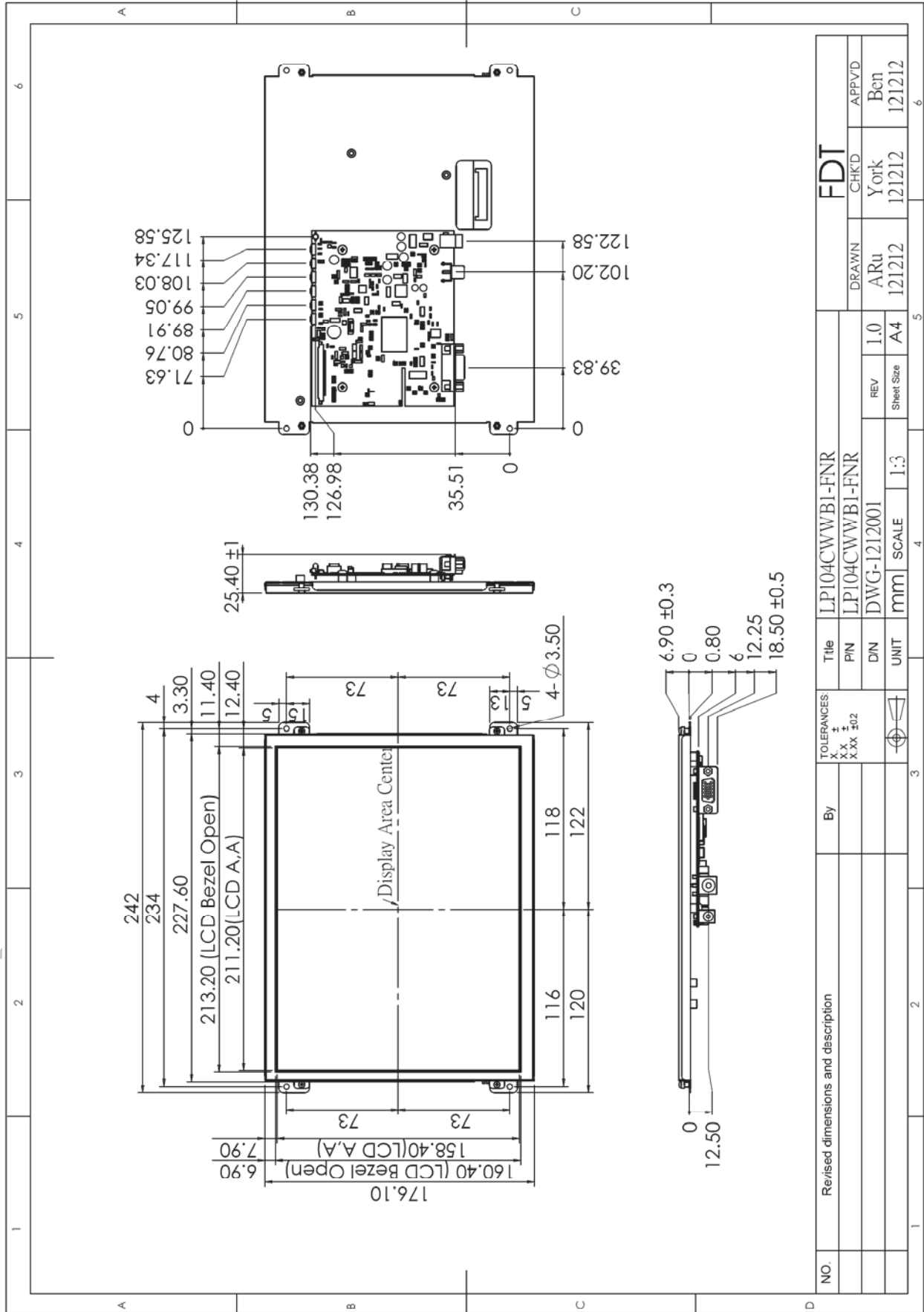

FLAT DISPLAY TECHNOLOGY

NO.	Revised dimensions and description	By	TOLERANCES: X ± XX ± XXX ±0.2	Title	LP104CWWB1-FNR	FDT		
				PIN	LP104CWWB1-FNR	DRAWN	CHK'D	APPVD
				DIN	DWG-1212001	ARu	York	Ben
				UNIT	mm	SCALE	1:3	Sheet Size
						REV	1.0	A4
						Sheet Size	A4	121212
							121212	121212

6.2 Unit (LP104CWWB4-FNR)

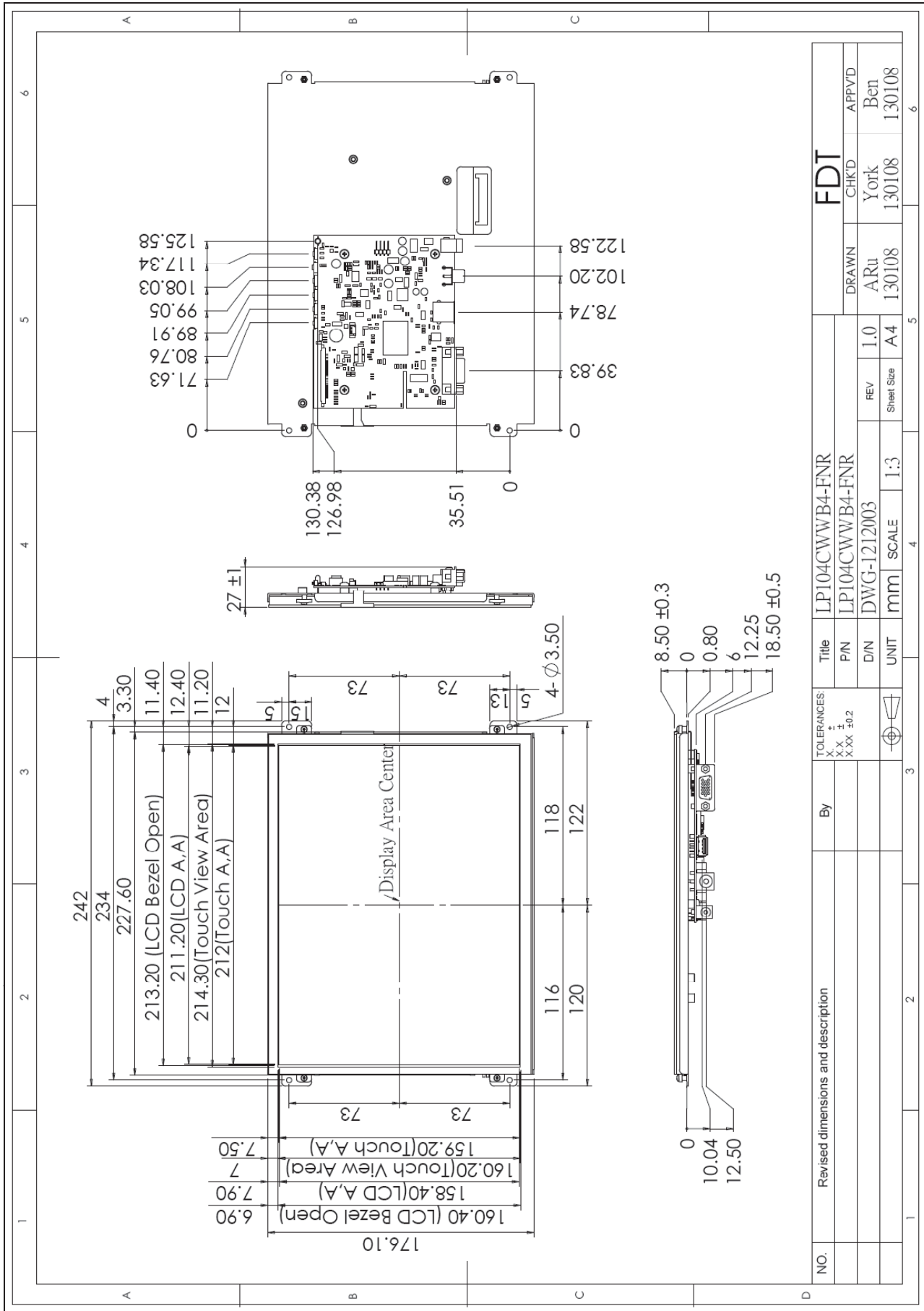

FLAT DISPLAY TECHNOLOGY

■ LP104CWWBx-FxR V0.1



6.3 Unit (LP104CWWB5-FNR)

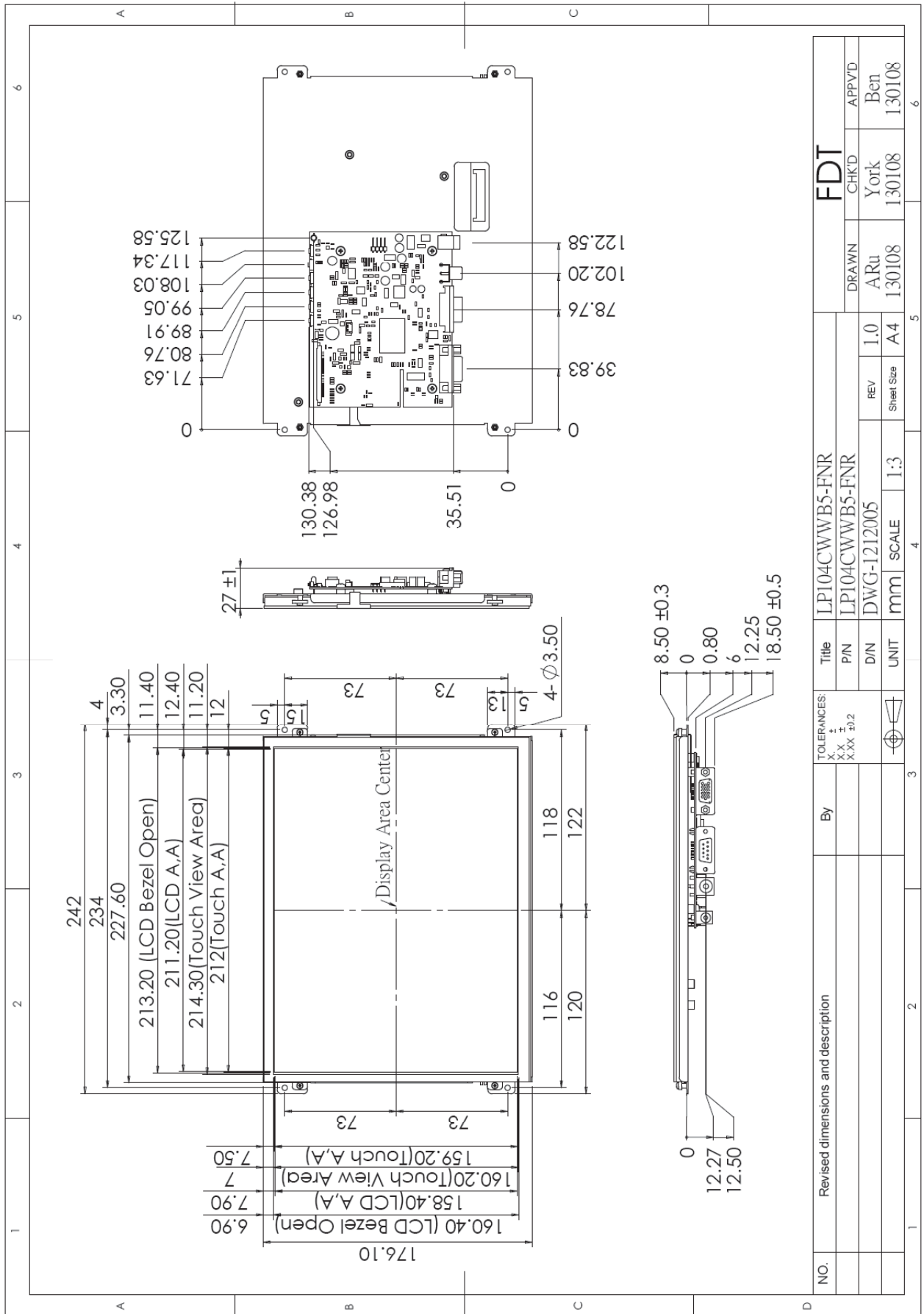

NO.	Revised dimensions and description	By	Title		FDT	
			LP104CWWB5-FNR	LP104CWWB5-FNR	CHK'D	APP'VD
			PIN	ARu	York	Ben
			D/WG-1212005	130108	130108	130108
			UNIT	REV	Sheet Size	
			mm	1.0	A4	
			SCALE	1:3		

FLAT DISPLAY TECHNOLOGY

■ LP104CWWB_X-F_XR V0.1



7. Pin Description

7.1 J301 : CPT LCD Panel I/O Terminals (Pitch 1.0mm 30Pin, Side Entry Type)

Pin No	Symbol	I/O	Description	Remark
1	GND	P	Ground	
2	VCC	I	Power supply: +3.3V	
3	VCC	I	Power supply: +3.3V	
4	NC	P	No Connection	
5	NC	P	No Connection	
6	NC	P	No Connection	
7	GND	P	Ground	
8	RX0-	I	Negative transmission data of pixel 0	
9	RX0+	I	Positive transmission data of pixel 0	
10	GND	P	Ground	
11	RX1-	I	Negative transmission data of pixel 1	
12	RX1+	I	Positive transmission data of pixel 1	
13	GND	P	Ground	
14	RX2-	I	Negative transmission data of pixel 2	
15	RX2+	I	Positive transmission data of pixel 2	
16	GND	P	Ground	
17	RXCLK-	I	Negative of clock	
18	RXCLK+	I	Positive of clock	
19	GND	P	Ground	
20	NC	P	No Connection	
21	NC	P	No Connection	
22	GND	P	Ground	
23	NC	P	No Connection	
24	NC	P	No Connection	
25	GND	P	Ground	
26	NC	P	No Connection	
27	NC	P	No Connection	
28	NC	P	No Connection	
29	NC	P	No Connection	
30	NC	P	No Connection	

7.2 J106B : Pin Assignment of Analog RGB Input (D-Sub 15Pin)

Pin No	Symbol	I/O	Description	Remark
1	RI+	I	Analog Red Signal	
2	GI+	I	Analog Green Signal	
3	BI+	I	Analog Blue Signal	
4	NC	-	No Connection	
5	GND	-	Ground	
6	AGND	-	Analog Ground	
7	AGND	-	Analog Ground	
8	AGND	-	Analog Ground	
9	NC	-	No Connection	
10	NC	-	No Connection	
11	NC	-	No Connection	
12	NC	-	No Connection	
13	HS_IN	I	TTL Horizontal sync	
14	VS_IN	I	TTL Vertical sync	
15	NC	-	No Connection	

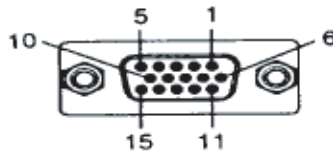

7.3 J104: Pin Assignment of UART (Pitch 1.25mm 4Pin, Top Entry Type)

- ※ FDT Connector Part No.: MS24014 (STM) [Same as 53398-0471 (MOLEX)];
- ※ FDT Matching Connector Part No.: P24014 (STM) [Same as 51021-0400 (MOLEX)].

Pin No	Symbol	I/O	Description	Remark
1	TX	O	UART Transmission Data	
2	RX	I	UART Receive Data	
3	GND	-	Ground	
4	+3.3V	O	+3.3V Output Voltage	

Note: All Functions can be controlled by UART, About UART command list please contact FDT sales.

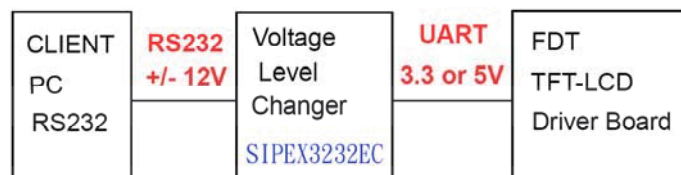

7.4 DC 101: Pin Assignment of Power Input (Inside Diameter:2.1 ϕ Outside Diameter:5.5 ϕ Side Entry Type)

Pin No	Symbol	I/O	Description	Remark
1	VIN	I	+12V Input Voltage	
2	GND	-	Power Ground	

7.5 RCA 101: Pin Assignment of Video Input (RCA JACK Yellow, Side Entry Type)

Pin No	Symbol	I/O	Description	Remark
1	Video	I	Video Input	
2	AGND	-	Analog Ground	

7.6 J404 : Pin Assignment of Touch USB (USBA-Female 2.0mm, Side Entry Type)(Option)

Pin No	Symbol	I/O	Description	Remark
1	DGND	-	Digital Ground	
2	D+	-	DATA (+)	
3	D-	-	DATA (-)	
4	VBUS	-	USB VCC	

7.7 DB401 : Pin Assignment of Touch RS232 (D-SUB 9 FEMALE)(Option)

Pin No	Symbol	I/O	Description	Remark
1	NC	-	No Connection	
2	TXD	-	Transmit Data	
3	RXD	-	Receive Data	
4	NC	-	No Connection	
5	GND	-	Ground	
6	NC	-	No Connection	
7	NC	-	No Connection	
8	NC	-	No Connection	
9	NC	-	No Connection	

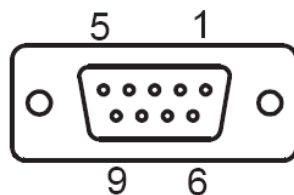

8. Absolute Maximum Ratings

8.1 Absolute Maximum Ratings

Parameter	Symbol	Min	Max	Unit	Remark
Input Voltage	Vin	+10	+13.2	V	
Video Input Signal	Video in	0.5	2.0	Vp-p	@75Ω
Analog RGB Input Signal	Analog RGB in	0.5	2.0	Vp-p	@75Ω
Digital Input Signal	TTL	+0.3	+3.6	V	
Operating Temperature		-20	+70	°C	
Storage Temperature		-30	+80	°C	
Operating Temperature With TSP		-5	+60	°C	
Storage Temperature With TSP		-30	+70	°C	

9. Recommended operating conditions

9.1 Electrical Characteristics

Parameter	Symbol	I/O	Min	Typ	Max	Unit	Note
Input Voltage	Vin	I	+10.8	+12	+13	V	
Total Current	Iin (+12V)	I		510		mA	±15%
Power Consumption		I		6.12		W	
Output Voltage	VDD	O	+3.2	+3.3	+3.4	V	I=10mA
Video Input Signal	Video in	I		1.0		Vp-p	@75Ω
Analog RGB Input Signal	Analog RGB in	RGB		0.7		Vp-p	@75Ω

9.2 VGA Mode Characteristics

Dots per inch	Hor.	Unit	Polarity	Ver.	Unit	Polarity	Note
640*480	31.469	KHz	Negative	59.941	Hz	Negative	
800*600	37.879	KHz	Positive	60.317	Hz	Positive	
1024*768	48.363	KHz	Negative	60.004	Hz	Negative	

FLAT DISPLAY TECHNOLOGY

■ LP104CWWBx-FxR V0.1



10. 4W Resistance Touch Panel Characteristics

10.1 Pin assignment

Pin No	Symbol	Description	Remark
1	YD	Upper Electrode Y (Down Side)	
2	XL	Lower Electrode X (Left Side)	
3	YU	Upper Electrode Y (Upper Side)	
4	XR	Lower Electrode X (Right Side)	

10.2 Electrical Performance

Parameter	Symbol	Min	Typ	Max	Unit	Remark
Terminal Resistance	X	200	-	1000	Ω	
	Y	100	-	800	Ω	
Linearity		-	-	2.0	%	
Insulation Impedance		10	-	-	M Ω	DC 25V
Response Time		-	-	20	ms	

10.3 Optical Performance

Parameter	Specifications
Light Transmittance	82.5% (Typ)
Haze	8 \pm 4% (Typ)

10.4 Mechanical Performance

Parameter	Specifications
Input Method	Finger or stylus pen
Operating Force	\leq 80g
Surface Hardness	3H or more

10.5 Durability Performance

Parameter	Specifications
Hitting Durability	\geq 1000000 times, with R8.0 mm silicon rubber, 200g
Sliding Durability	\geq 100000 times, with R0.8 mm polyacetal stylus, 250g

10.6 Mechanical Design Notice For Touch Panel

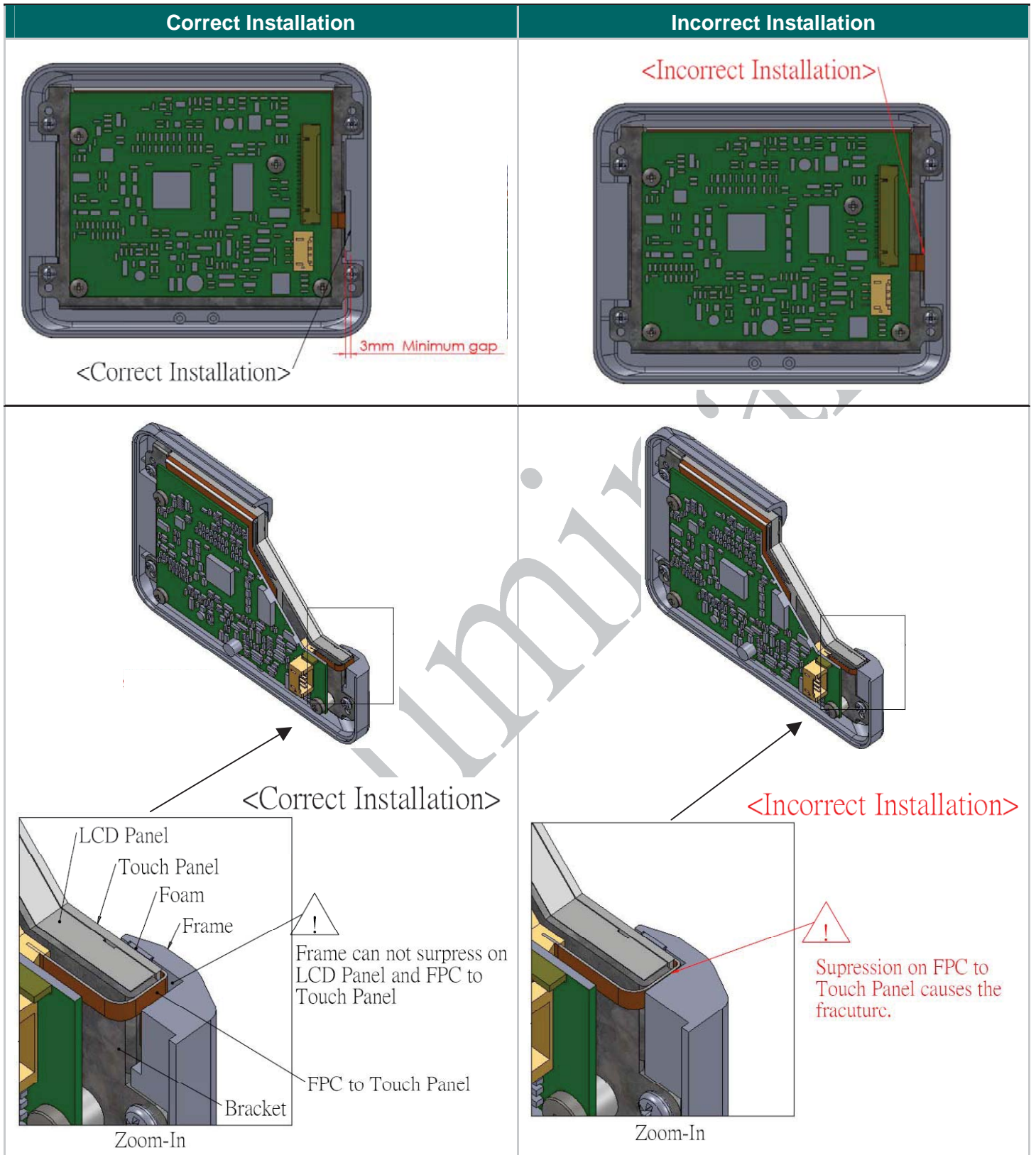

11. Operation manual

11.1 Driver Board Manual

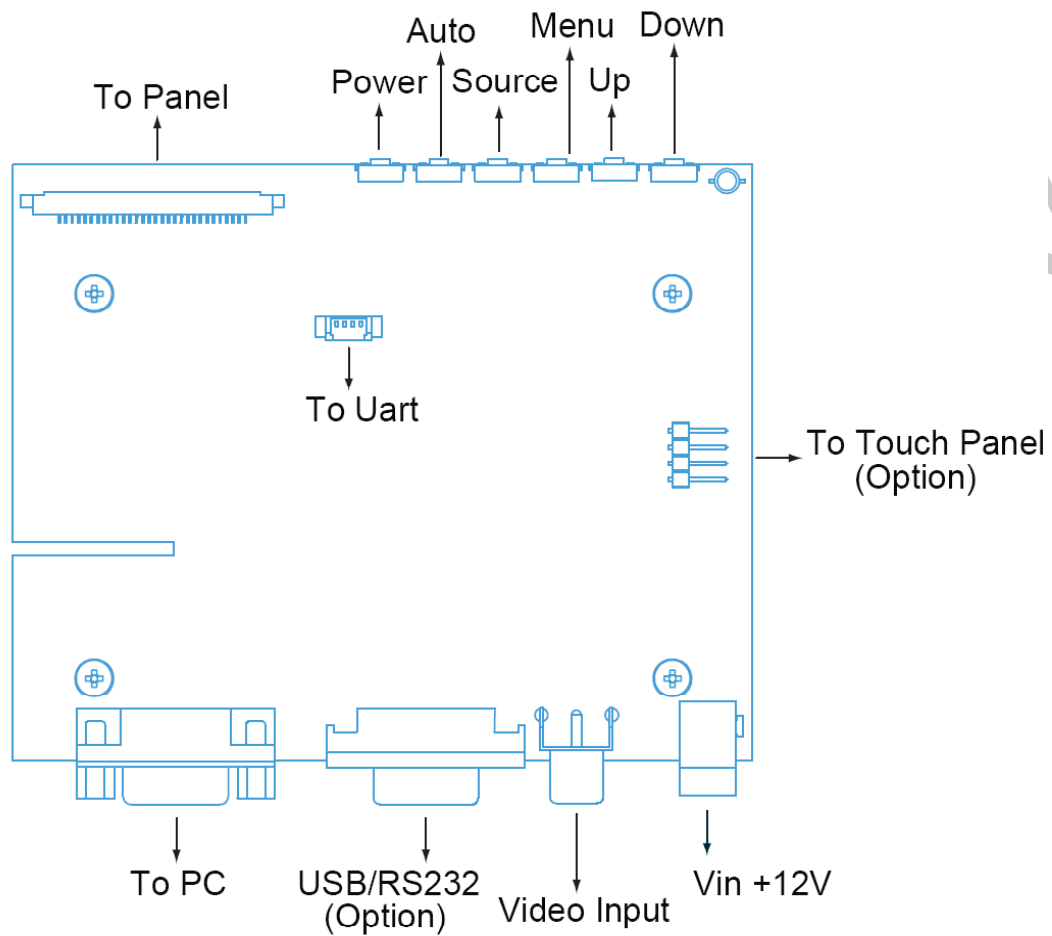

12. Packing List

Before you begin installing the KIT, please make sure that the following materials have been shipped:



A. LASTD12030-FDR



B. LAACD18000-FDR



C. LAVDO18000-FDR



D. LAVGA16000-FDR



E. LAUSB18000-FDR



F. LARS218000-FDR



G.

- A. AC to DC Adapter (L: 1500mm, 100-240VAC 50-60Hz to +12VDC @ 3A)
- B. Power Cord (L: 1800mm, Plug Type B for USA)
- C. Video Cable (L: 1800mm)
- D. VGA Cable (L: 1600mm)
- E. USB Cable (L: 1800mm, Only LP104CWWB4-F~~X~~R)
- F. RS-232 Cable (L: 1800mm, Only LP104CWWB5-F~~X~~R)
- G. Touch Screen Driver CD Disk / User Manual (Only LP104CWWB4-F~~X~~R, LP104CWWB5-F~~X~~R)

If any of these items are missing or damaged, contact your distributor or sales representative immediately.

FLAT DISPLAY TECHNOLOGY

■ LP104CWWB~~X~~-F~~X~~R V0.1



13. Key Function by OSD

13.1 Menu Operation

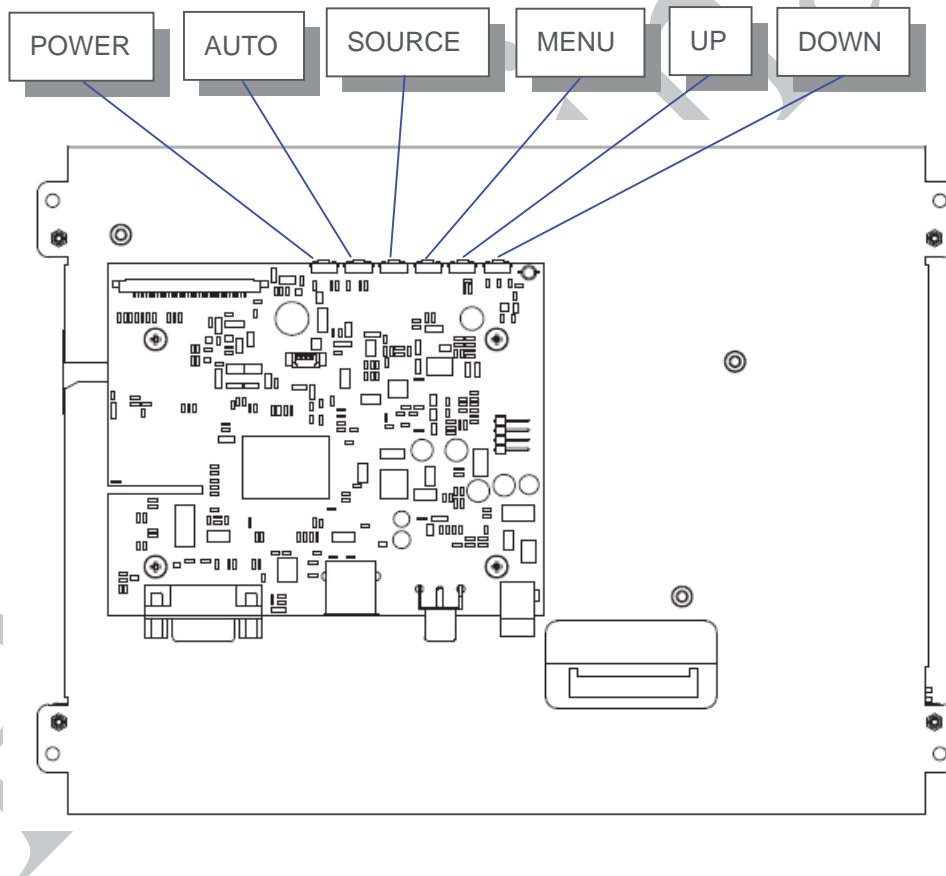
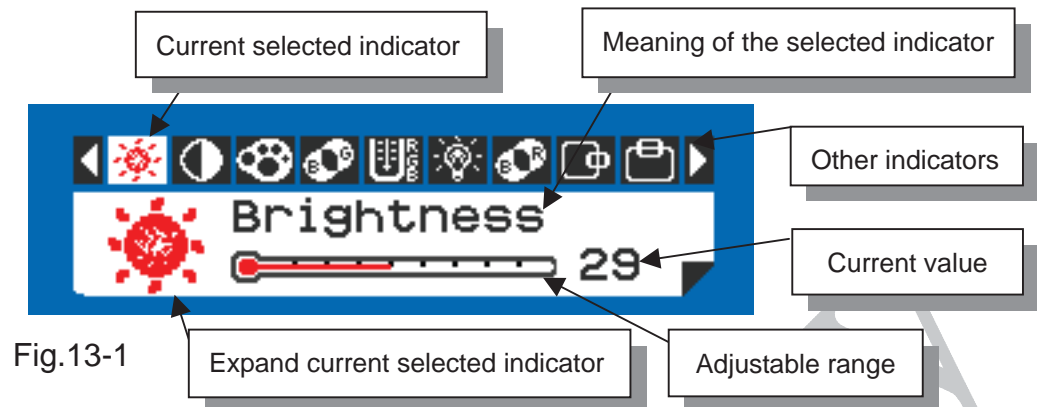

Operations of key board :

1. To navigate the menu, press [MENU]. (Fig.13-1)
2. The indicator lighting up in white color is the selected adjustment item.
3. To Next Item of the menu, press [MENU] again.
4. The operations below are only available when "Menu" is started.
5. Press [UP] / [DOWN] to adjust the value of the selected item.

FLAT DISPLAY TECHNOLOGY

■ LP104CWVWx-FxR V0.1



Overview of the menu :

Firmware must be \geq VER 0.26

Indicator	Meaning	Adjustable range	For	Remark
	Brightness	0 ~ 64	AV / VGA	Adjust-Bar
	Contrast	0 ~ 64	AV / VGA	Adjust-Bar
	Color	0 ~ 64	AV	Adjust-Bar
	Tint	0 ~ 32	AV	Adjust-Bar
	Sharpness	0 ~ 16	AV	Adjust-Bar
	Dimmer	0 ~ 9	AV / VGA	
	Color Tone	Normal / Warm / Cool	AV / VGA	
	H-Position	-25 ~ +25	AV / VGA	Balance-Bar
	V-Position	-10 ~ +10	AV / VGA	Balance-Bar
	Auto		VGA	
	Scan	Over Scan / Under Scan	AV	
	Information		AV / VGA	Fig.13-2
	Setup		AV / VGA	Fig.13-3
	Factory Set		AV / VGA	
	Exit		AV / VGA	

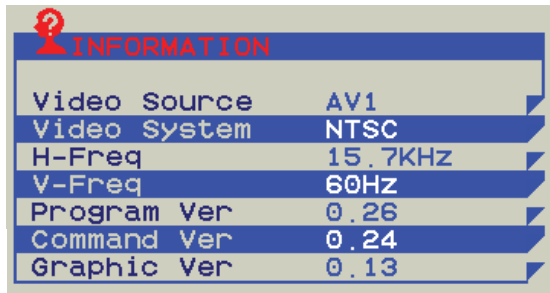







Fig.13-2

Setup Menu :



Fig.13-3

Indicator	Meaning	Adjustable range	Function	Remark
	Show Status	ON / OFF	Show signal status.	ON: Show OFF: Hidden
	Blue Screen	ON / OFF	If loss signal will put on the blue or black screen.	ON: Blue OFF: Black
	Auto Power On	ON / OFF	Power input module will be auto turn on.	ON: Auto OFF: Manual
	Auto Saving	OFF / 3s / 5s / 15s / 30s	If signal lost over setting times will be power off.	ON: Auto OFF: Normal
	Detect Source	ON / OFF	Auto detection which source is existence and change.	ON: Auto OFF: Normal
	Return			

Note : VGA only type don't have Detect Source function.

13.2 Operations

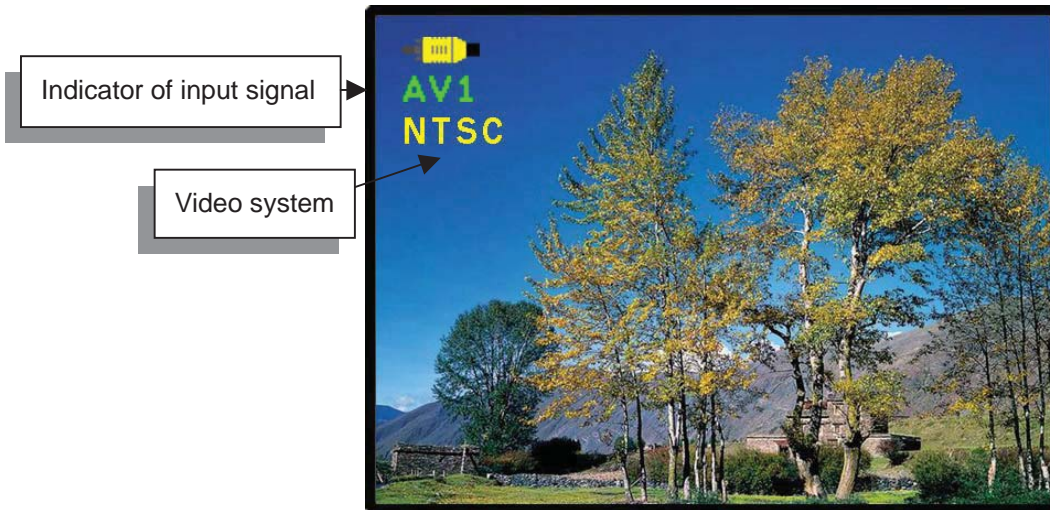



Fig.13-4

[Power] : Monitor power on / off

[Source] : Input signal switch

Overview of input signals :

Indicator	Input signal	Interface	Video system
	AV1	Composite	NTSC / PAL / SECAM
	VGA	Analog RGB	640x480_60 / 800x600_60 / 1024x768_60