



## § SPECIFICATION APPROVAL SHEET §

Fdt Tech Module No: **LP150X001x-FNR**

Description: **15" Digital TFT-LCD Module**

SPEC No.: **SAS-1403010**

Version: **1.0**

Issue Date: **March 11, 2014**

※ This approval sheet contains 25 pages including the cover and appendix.

Customer:	Approved By:
Date:     /     / 14	

Approved By: \_\_\_\_\_      Checked By: \_\_\_\_\_      Designed By: \_\_\_\_\_

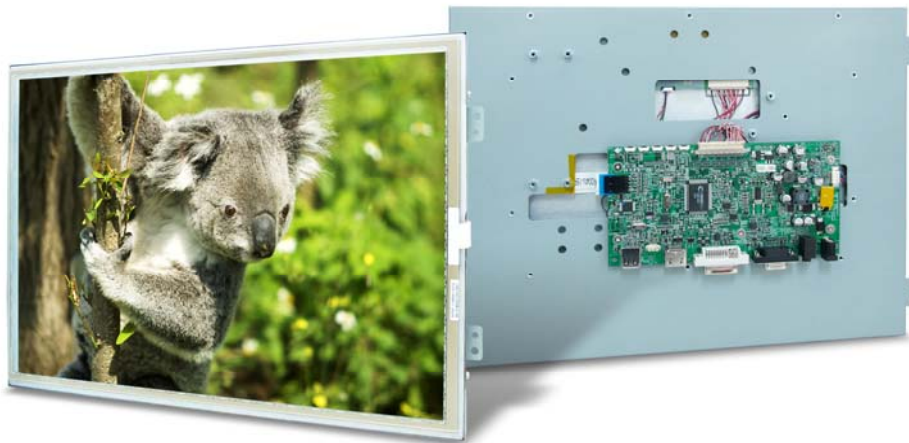

## 1. General Description

### 1.1 Features

- 15" (1024x768) Digital TFT LCD
- Aspect Ratio: 4:3
- Input Signal VGA / DVI-D/ HDMI 1.3a
- Maximum Support Resolution 1920x1080
- Stereo Audio Amplifier, Output 2W@4Ω Speaker
- Audio Line-In / Line-Out (Optional)
- 5 Wires Resistive Touch Panel
- 5 Key Buttons Control
- UART / RS232 Serial Remote Control (Optional)
- 8 Language OSD Menu
- Light Sensor (Optional)
- LED Backlight
- Single Operation Voltage +12V

### 1.2 Applications

- Industrial
- Medical Environment
- Instrument Display
- Kiosk
- Security
- Signage
- Office Electronics
- Home Application
- Educate Application



## 2. Contents

Contents	Page
<b>1. General Description</b> .....	<b>1</b>
1.1 Features	1
1.2 Applications	1
<b>2.Contents</b> .....	<b>2-3</b>
<b>3 .Specifications</b> .....	<b>4</b>
<b>4. Black Diagram</b> .....	<b>4</b>
<b>5. TFT-LCD Information</b> .....	<b>5</b>
5.1 TFT-LCD Mechanical Specifications	5
5.2 TFT-LCD Optical Characteristics	5
<b>6. Order Information</b> .....	<b>6</b>
6.1 Unit	6
<b>7. Dimension Information</b> .....	<b>7-9</b>
7.1 Unit (LP150X0010-FNR)	7
7.2 Unit (LP150X001U-FNR)	8
7.3 Unit (LP150X001R-FNR)	9
<b>8. Pin Description</b> .....	<b>10-14</b>
8.1 J103 : Pin Assignment of Power Input (DC Jack Inside Diameter:2.1 $\phi$ Outside Diameter:5.5 $\phi$ Side Entry Type)	10
8.2 J702 : Pin Assignment of UART (Pitch 1.25mm 4Pin, Top Entry Type)	10
8.3 J503 : Pin Assignment of Analog RGB Input ( D-Sub 15Pin)	10
8.4 J401 : Pin Assignment of DVI-D (24 Pin)	11
8.5 J402 : Pin Assignment of HDMI-A Type Input (HDMI 1.3a -19Pin Female)	12
8.6 J602A : Pin Assignment of Key Board (Pitch 1.25mm 12Pin , Side Entry Type)	12
8.7 J303 : Pin Assignment of Spear Left (Pitch 2.0mm 2Pin , Top Entry Type)	13
8.8 J302 : Pin Assignment of Spear Right (Pitch 2.0mm 2Pin , Top Entry Type)	13
8.9 J701 : Pin Assignment of Touch USB (USB A Type - Female 2.0mm, Side Entry Type )(Option)	13
8.10 J705 : Pin Assignment of Touch RS232 (D-Sub 9 Female)(Option)	13
8.11 J301 : Pin Assignment of Line-In/Out (Option) (Outside Diameter:3.5 $\phi$ Side Entry Type)	14
<b>9. Absolute Maximum Ratings</b> .....	<b>14</b>
9.1 Absolute Maximum Ratings	14
<b>10. Recommended Operating Conditions</b> .....	<b>14</b>
10.1 Electrical Characteristics	14
10.2 VGA Mode Characteristics	14
<b>11. 5W Resistive Touch Panel Characteristics</b> .....	<b>15-18</b>
11.1 Electrical Performance	15
11.2 Optical Performance	15
11.3 Mechanical Performance	15



11.4 Durability Performance	15
11.5 5W Resistive Touch Panel Operation System Support	16
11.6 Resistive Touch Panel Integration Design Guide	17
11.7 Mechanical Design Notice For Resistive Touch Panel	18
<b>12. Operation manual / Connection</b> .....	<b>19</b>
12.1 Driver Board Manual	19
<b>13. Accessories (Option)</b> .....	<b>20</b>
<b>14. Key Function by OSD</b> .....	<b>21-24</b>
14.1 Menu Operation	21-24

## 3. Specifications

LCD	
Panel Size	15"
Resolution (Pixels)	1024x768
Color	16.2M
Luminance w/o RTP	250 cd/m <sup>2</sup>
Luminance (RTP)	200 cd/m <sup>2</sup>
Luminance (PCT)	215 cd/m <sup>2</sup>
Contrast Ratio	700
Viewing Angle	80 / 80 / 70 / 70
Backlight Life Time (LED)	50K (Min)
Power Requirement	
Power Input (DC Jack 2.1 $\phi$ )	+12 V <sub>DC</sub>
PowerConsumption@+12V	10.2 Watts (@Without Amplifier)
Touch Screen	
Resistive Type	USB / RS232 Interface
Resistive Type Support OS	Windows / Linux / DOS / Mac / QNX
Projected Capacitive Touch	USB Interface ( 2 Points )
Projected Capacitive Touch Support OS	Windows / Android / Linux

Input Signal	
VGA	D-Sub15
DVI	DVI-D
HDMI	1.3a
Audio	
Amplifier	1W@8 $\Omega$ / 2W@4 $\Omega$
Line-In	Stereo Input Phone Jack $\phi$ 3.5
Controls	
Key	5 Buttons
Serial Remote Control	UART / RS232 (Optional)
Environment	
Operating Temp. w/o RTP	-20 ~ +70 $^{\circ}$ C
Storage Temp. w/o RTP	-30 ~ +70 $^{\circ}$ C
Operating Temp. 5W RTP	-10 ~ +70 $^{\circ}$ C
Storage Temp. 5W RTP	-30 ~ +70 $^{\circ}$ C
Operating Temp. PCT	-20 ~ +70 $^{\circ}$ C
Storage Temp. PCT	-20 ~ +70 $^{\circ}$ C

## 4. Block Diagram

LP150X001x-FNR

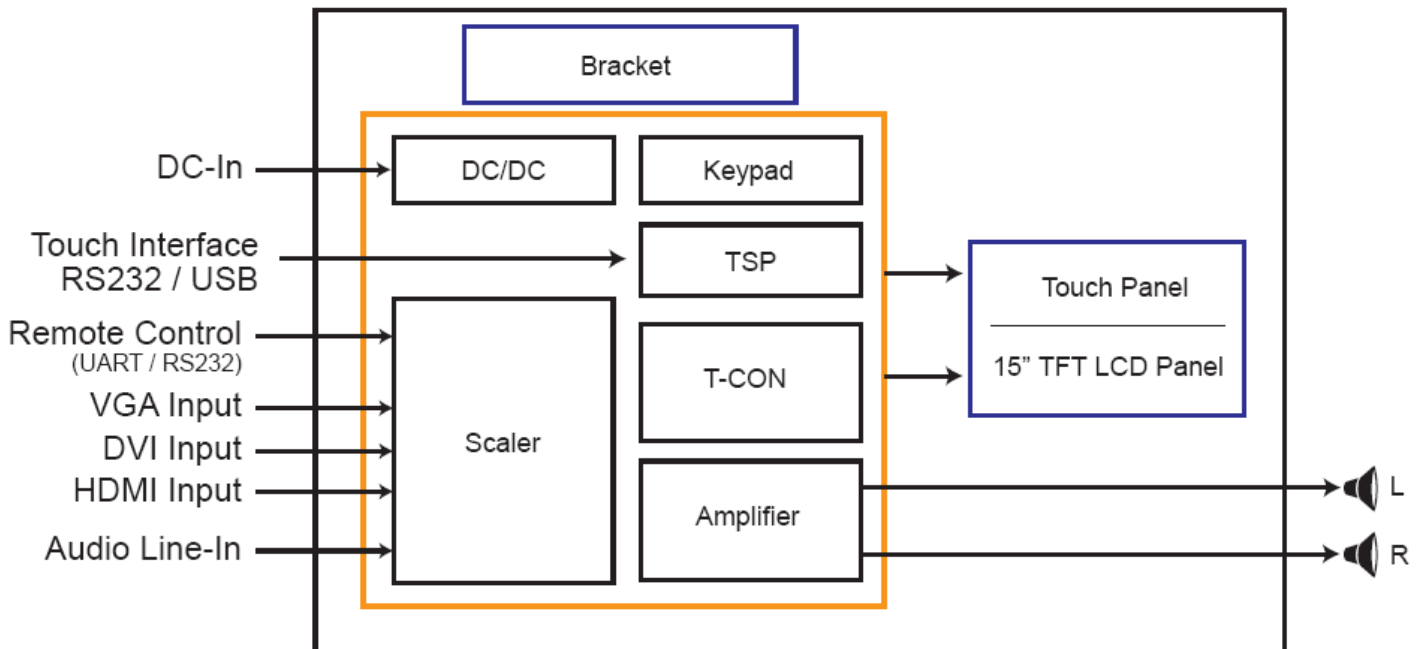



## 5. TFT-LCD Information

### 5.1 TFT-LCD Mechanical Specifications

Parameter	Specifications	Unit
Screen Size	15 (diagonal)	Inch
Display Format	1024 x (R.G.B) x 768	Dot
Active Area	304.1(H) x 228.1(V)	mm
Pixel Pitch	0.297(H) x 0.297(V)	mm
Pixel Arrangement	RGB vertical stripe	
Surface Treatment	Anti-Glare, Haze=25%, Hard Coating (3H)	

### 5.2 TFT-LCD Optical Characteristics

Parameter	Symbol	Condition	Min	Typ	Max	Unit	Remark
Viewing Angle	Horizontal	Left	CR >10	70	80	---	deg
		Right		70	80	---	deg
	Vertical	Top		50	70	---	deg
		Bottom		50	70	---	deg
Contrast Ratio	CR	At optimized Viewing angle	450	700	---	---	
Luminance w/o RTP	L		200	250	---	cd/m <sup>2</sup>	
Backlight Life Time (LED)		25°C	50000	---	---	Hrs	



## 6. Order Information

### 6.1 Unit

Parameter	LP150X0010-FNR	LP150X001U-FNR	LP150X001R-FNR
VGA	⊙	⊙	⊙
DVI	⊙	⊙	⊙
HDMI	⊙	⊙	⊙
Touch Panel Type	-	5W Resistive	5W Resistive
Touch Screen Interface	-	USB	RS232
Audio Amplifier	⊙	⊙	⊙
Audio Line-In	⊙	⊙	⊙
5 Keys	⊙	⊙	⊙
UART Remote Control	⊙	⊙	⊙

**Note: 1.**The assembling of panel and bracket is aimed for delivery, packaging and experiment. If the demand of shockproof and long-term fix, pls have it into consideration of mechanism design.

Optional Functions	
Parameter	<ul style="list-style-type: none"> <li>- Audio Line-Out</li> <li>- RS232 Remote Control</li> <li>- Back Cover</li> <li>- External Key</li> <li>- Light Sensor</li> <li>- Accessories (Refer to Page 20)</li> </ul>





**7.2 Unit (LP150X001U-FNR)**

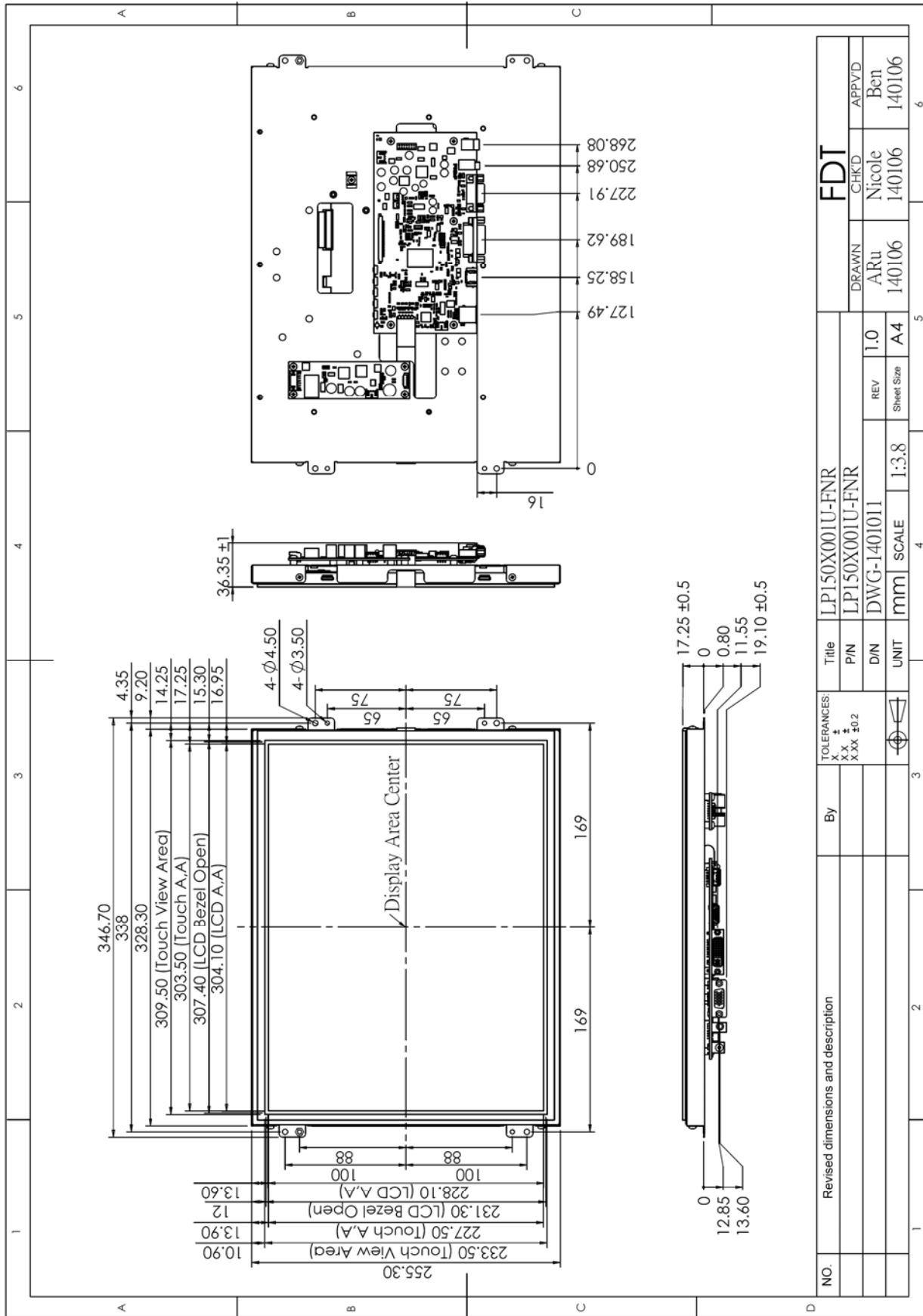

**7.3 Unit (LP150X001R-FNR)**

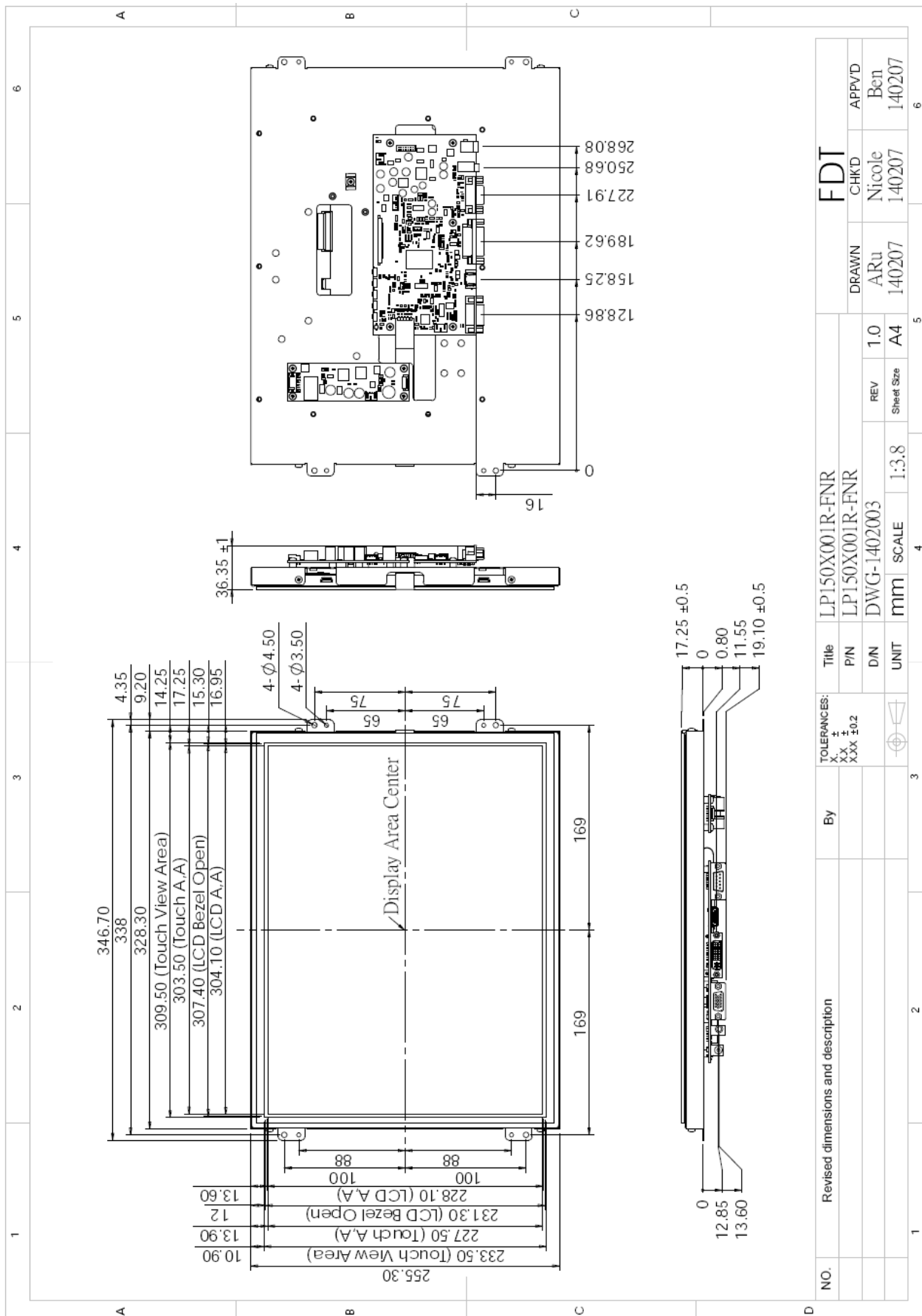

## 8. Pin Description

### 8.1 J103 : Pin Assignment of Power Input (DC-Jack Inside Diameter:2.1 $\phi$ Outside Diameter:5.5 $\phi$ Side Entry Type)

Pin No.	Symbol	I/O	Description	Remark
1	DC-In	I	+12Vdc Input Voltage	
2	GND	-	Power Ground	

### 8.2 J702 : Pin Assignment of UART (Pitch 1.25mm 4Pin, Top Entry Type)

※ FDT Connector Part No.: MS24014 (STM) [Same as 53398-0471 (MOLEX)] ;

※ FDT Matching Connector Part No.: P24014 (STM) [Same as 51021-0400 (MOLEX)].

Pin No.	Symbol	I/O	Description	Remark
1	TX / RS232 TX (Option)	O	UART / RS232 (Option) Transmission Data	
2	RX / RS232 RX (Option)	I	UART / RS232 (Option) Receive Data	
3	GND	-	Ground	
4	+3.3Vdc	O	+3.3Vdc Output Voltage	

**Note: All Functions can be controlled by UART , About UART command list please contact FDT sales.**

### 8.3 J503 : Pin Assignment of Analog RGB Input ( D-Sub 15Pin)

Pin No.	Symbol	I/O	Description	Remark
1	RI+	I	Analog Red Signal	
2	GI+	I	Analog Green Signal	
3	BI+	I	Analog Blue Signal	
4	GND	-	Ground	
5	VGA-Det	I	VGA Detect	
6	AGND	-	Analog Ground	
7	AGND	-	Analog Ground	
8	AGND	-	Analog Ground	
9	VGA5V	-	VGA +5Vdc Input	
10	GND	-	Ground	
11	GND	-	Ground	
12	VGA_SDA	-	DDC2 Data	
13	HS_IN	I	TTL Horizontal sync.	
14	VS_IN	I	TTL Vertical sync.	
15	VGA_SCL	-	DDC2 Clock	

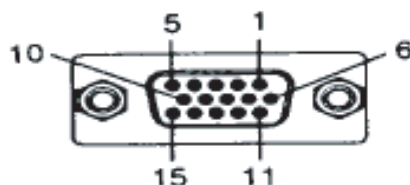

## 8.4 J401 : Pin Assignment of DVI-D (24 Pin)

Pin No.	Symbol	I/O	Description	Remark
1	DATA2-	I	Negative DVI Input for A Link Data Channel 2	
2	DATA2+	I	Positive DVI Input for A Link Data Channel 2	
3	GND	-	Ground	
4	NC	-	No Connection	
5	NC	-	No Connection	
6	DVI_SCL	I	DDC2 Clock	
7	DVI_SDA	I	DDC2 Data	
8	NC	-	No Connection	
9	DATA1-	I	Negative DVI Input for A Link Data Channel 1	
10	DATA1+	I	Positive DVI Input for A Link Data Channel 1	
11	GND	-	Ground	
12	NC	-	No Connection	
13	NC	-	No Connection	
14	DVI5V	I	DVI +5Vdc Input	
15	DET_DVI	I	DVI Detect	
16	DVI_HPD	-	Hot Plug Detect	
17	DATA0-	I	Negative DVI Input for A Link Data Channel 0	
18	DATA0+	I	Positive DVI Input for A Link Data Channel 0	
19	GND	-	Ground	
20	NC	-	No Connection	
21	NC	-	No Connection	
22	GND	-	Ground	
23	DCLK+	I	Positive DVI Input for A Link Clock Channel	
24	DCLK-	I	Negative DVI Input for A Link Clock Channel	

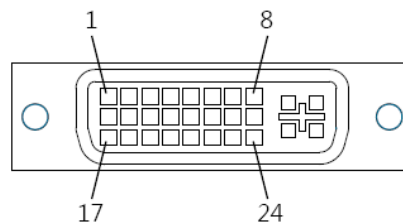

### 8.5 J402 : Pin Assignment of HDMI-A Type Input (HDMI 1.3a -19Pin Female)

Pin No.	Symbol	I/O	Description	Remark
1	DATA2+	I	Positive HDMI Input for B Link Data Channel 2	
2	DET_HDMI	-	HDMI Detect	
3	DATA2-	I	Negative HDMI Input for B Link Data Channel 2	
4	DATA1+	I	Positive HDMI Input for B Link Data Channel 1	
5	GND	-	Ground	
6	DATA1-	I	Negative HDMI Input for B Link Data Channel 1	
7	DATA0+	I	Positive HDMI Input for B Link Data Channel 0	
8	GND	-	Ground	
9	DATA0-	I	Negative HDMI Input for B Link Data Channel 0	
10	DCLK+	I	Positive HDMI Input for B Link Clock Channel	
11	GND	-	Ground	
12	DCLK-	I	Negative HDMI Input for B Link Clock Channel	
13	NC	-	No Connection	
14	NC	-	No Connection	
15	HDMI_SCL	I	DDC2 Clock	
16	HDMI_SDA	I	DDC2 Data	
17	GND	I	DDC/CEC Ground	
18	HDMI5V	I	HDMI +5Vdc Input	
19	HDMI_HPD	I	Hot Plug Detect	

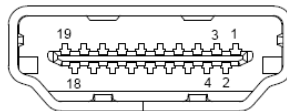

### 8.6 J602A : Pin Assignment of Key Board (Pitch 1.25mm 12Pin , Side Entry Type)

※ FDT Connector Part No.: MS240112R (STM) [Same as 53261-1219 (MOLEX)] ;

※ FDT Matching Connector Part No.: P240112 (STM) [Same as 51021-1200 (MOLEX)].

Pin No.	Symbol	I/O	Description	Remark
1	-	-	Don't Connect	
2	SW5	I	EXIT	
3	SW4	I	DOWN	
4	SW3	I	UP	
5	SW2	I	MENU / S	
6	SW1	I	POWER / SOURCE	
7	GND	-	Ground	
8	VDDP	-	VDDP +3.3Vdc Output Voltage	
9	-	-	Don't Connect	
10	RED	O	Indicator red LED for power off control	
11	GREEN	O	Indicator green LED for power on control	
12	GND	-	Ground	

**8.7 J303 : Pin Assignment of Spear Left (Pitch 2.0mm 2Pin , Top Entry Type)**

※ FDT Connector Part No.: A2001WV2-2P(JWT) ;

※ FDT Matching Connector Part No.: A2001H02-2P(JWT) .

Pin No.	Symbol	I/O	Description	Remark
1	+LOUT	O	Left Speaker Out+	
2	-LOUT	O	Left Speaker Out -	

**8.8 J302 : Pin Assignment of Spear Right (Pitch 2.0mm 2Pin , Top Entry Type)**

※ FDT Connector Part No.: A2001WV2-2P(JWT) ;

※ FDT Matching Connector Part No.: A2001H02-2P(JWT) .

Pin No.	Symbol	I/O	Description	Remark
1	+ROUT	O	Right Speaker Out+	
2	-ROUT	O	Right Speaker Out-	

**8.9 J701 : Pin Assignment of Touch USB (USB A Type - Female 2.0mm, Side Entry Type )(Option)**

Pin No.	Symbol	I/O	Description	Remark
1	DGND	-	Digital Ground	
2	D+	-	DATA (+)	
3	D-	-	DATA (-)	
4	VBUS	-	USB VCC	

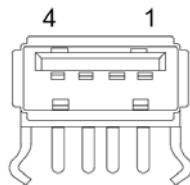

**8.10 J705 : Pin Assignment of Touch RS232 (D-SUB 9 Male)(Option)**

Pin No.	Symbol	I/O	Description	Remark
1	-	-	Don't Connect	
2	RXD	I	Receive Data	
3	TXD	O	Transmit Data	
4	-	-	Don't Connect	
5	GND	-	Ground	
6	NC	-	No Connection	
7	NC	-	No Connection	
8	-	-	Don't Connect	
9	-	-	Don't Connect	

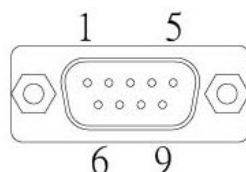

## 8.11 J301 : Pin Assignment of Line-In/Out (Option) (Outside Diameter:3.5 φSide Entry Type)

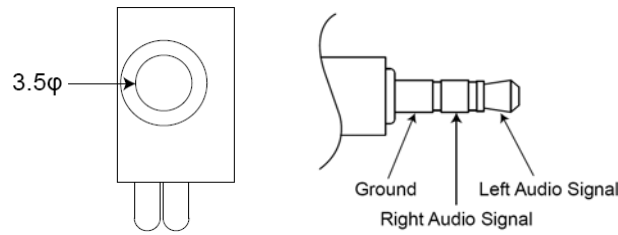

## 9. Absolute Maximum Ratings

### 9.1 Absolute Maximum Ratings

Parameter	Symbol	Min	Max	Unit	Remark
Input Voltage	V <sub>in</sub>	11	13.5	V	
Analog RGB Input Signal	Analog RGB in	0.5	2.0	V <sub>p-p</sub>	
Digital Input Signal	TTL	0.3	3.6	V	
DVI Input Signal		-	165	MHz	
HDMI Input Signal		-	165	MHz	
Line-in			1.8	V <sub>p-p</sub>	
Operating Temp. w/o TP		-20	+70	°C	
Storage Temp. w/o TP		-30	+70	°C	
Operating Temp. 5W RTP		-10	+70	°C	
Storage Temp. 5W RTP		-30	+70	°C	

## 10. Recommended Operating Conditions

### 10.1 Electrical Characteristics

Parameter	Symbol	I/O	Min	Typ	Max	Unit	Note
Input Voltage	DC-in	I	+11.5	12	+13	V	
Total Current	I-in	I		850		mA	+12V
Power Consumption		I		10.2		W	@Without Amplifier
Output Voltage	VDD	O	3.2	3.3	3.4	V	
Analog RGB Input Signal	Analog RGB in	RGB		0.7		V <sub>p-p</sub>	@75Ω
DVI Input Signal					165	MHz	
HDMI Input Signal					165	MHz	

### 10.2 VGA Mode Characteristics

Dots per inch	H	Unit	Polarity	V	Unit	Polarity	Note
640 x 480	31.47	KHz	Positive	59.9	Hz	Positive	
800 x 600	37.88	KHz	Positive	60.3	Hz	Positive	
1024 x 768	48.36	KHz	Positive	60	Hz	Positive	
1280 x 1024	63.98	KHz	Positive	60	Hz	Positive	
1600 x 1200	75	KHz	Positive	60	Hz	Positive	
1920 x 1080	67.5	KHz	Positive	60	Hz	Positive	

## 11. 5W Resistive Touch Panel Characteristics

### 11.1 Electrical Performance

Parameter	Symbol	Min	Typ	Max	Unit	Note
Terminal Resistance	X	20		500	$\Omega$	
	Y	20		500	$\Omega$	
Linearity				1.5	%	
Insulation Impedance		20			M $\Omega$	DC 25V
Response Time				15	ms	

### 11.2 Optical Performance

Parameter	Specifications
Light Transmittance	80% $\pm$ 2%
Haze	< 9.5% $\pm$ 2%

### 11.3 Mechanical Performance

Parameter	Specifications
Input Method	Stylus or Finger
Operating Force	R0.8 Silicon Rubber, < 50gf
Surface Hardness	3H pencil, pressure 1N/45°

### 11.4 Durability Performance

Parameter	Specifications
Knock Test	10,000,000 times





## 11.5 Resistive Touch Panel Operation System Support

OS	Version	Interface	
<b>Windows</b>	Windows Vista, XP / 200, 9x / ME Windows Embedded Windows 7	RS232 / USB	
	Windows NT4	RS232	
	<b>Linux</b>	Mandrake (Mandrake 9.1 / 9.2 / 10, Mandriva 2005, Mandriva 2006) Red Hat (7.3 / 8.0 / 9.0) Fedora (Core I / II / III / IV / V / VI) Yellow Dog (3.X) SuSE (9.2 / 9.3 / 10 / 10.1) Ubuntu (5.1 / 6.06) Debian (3.1, Kernel 2.1.x / 2.6.x)	RS232 / USB
		Android 1.5 – Google Moblin V2 - Intel	RS232 / USB
<b>DOS</b>		DOS	RS232
<b>Mac</b>		Mac OS9, Mac OS X (IBM, intel CPU)	USB
<b>QNX</b>		QNX RTOS v6.3	RS232 / USB

## 11.6 Resistive Touch Panel Integration Design Guide

Avoid the design that Front-case overlap and press on the active area of the touch-panel.

Give enough gap (over 0.5mm at compressed) between the front case and touch-panel to protect wrong operating.

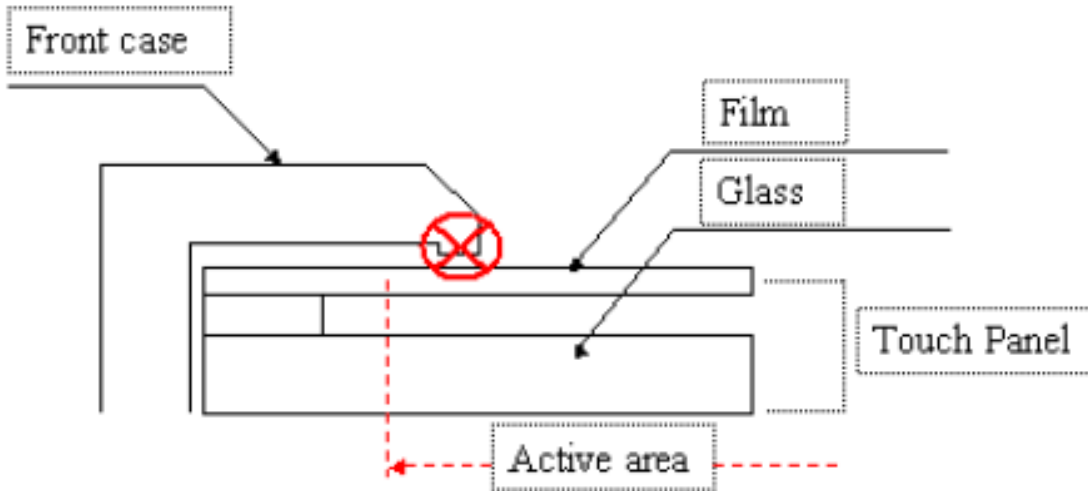

Use a buffer material (Gasket) between the touch-panel and front-case to protect damage and wrong operating.

Avoid the design that buffer material overlap and press on the inside of touch-panel viewing area.

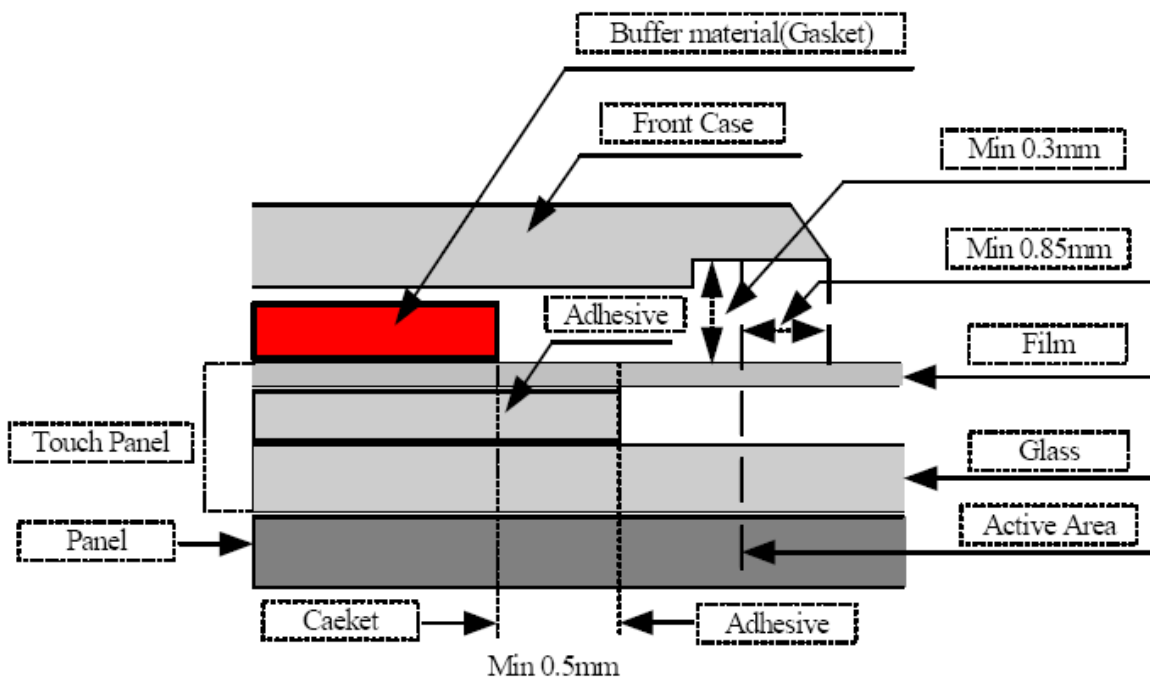

## 11.7 Mechanical Design Notice For Resistive Touch Panel

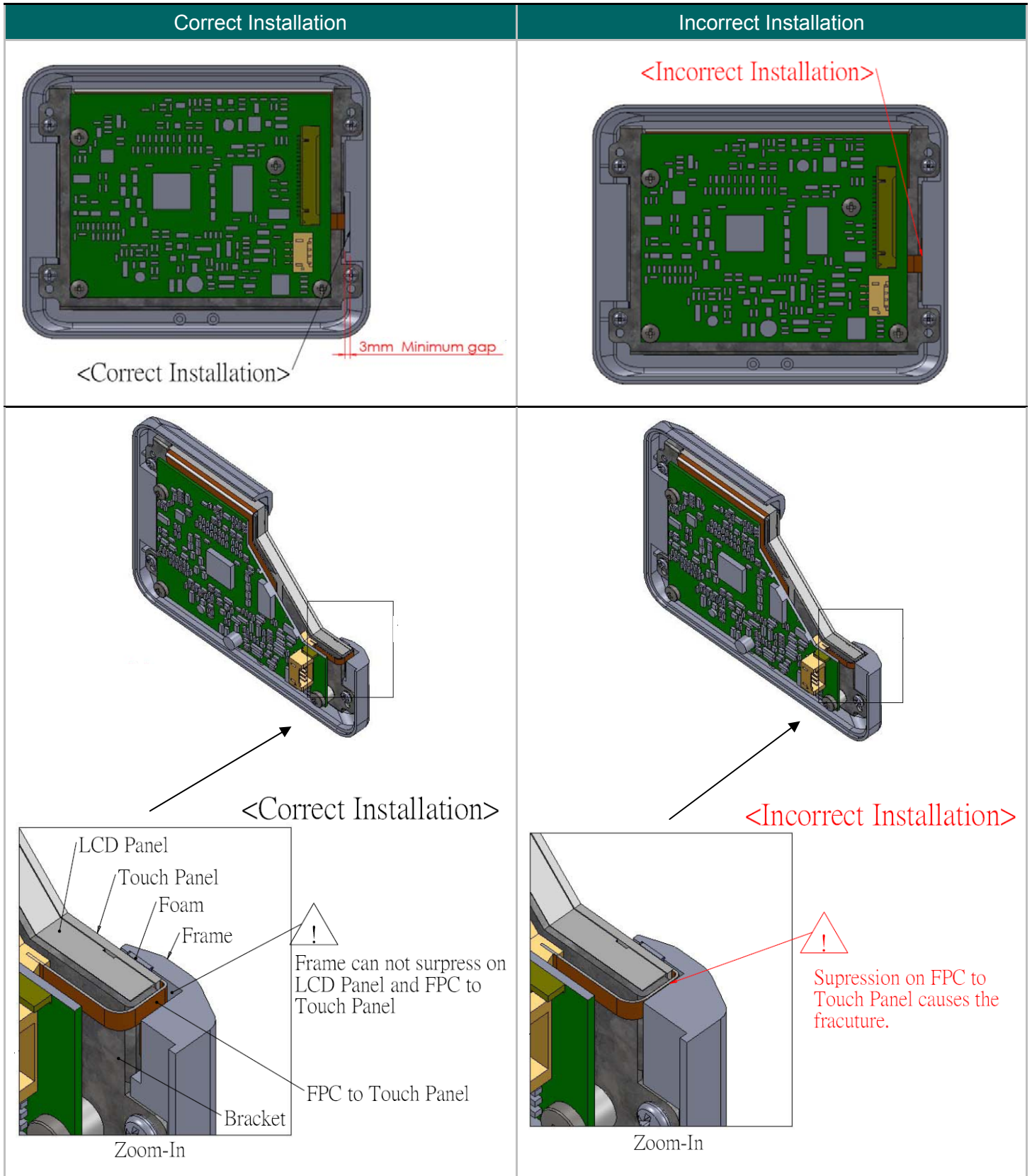

## 12. Operation manual / Connection

### 12.1 Driver Board Manual

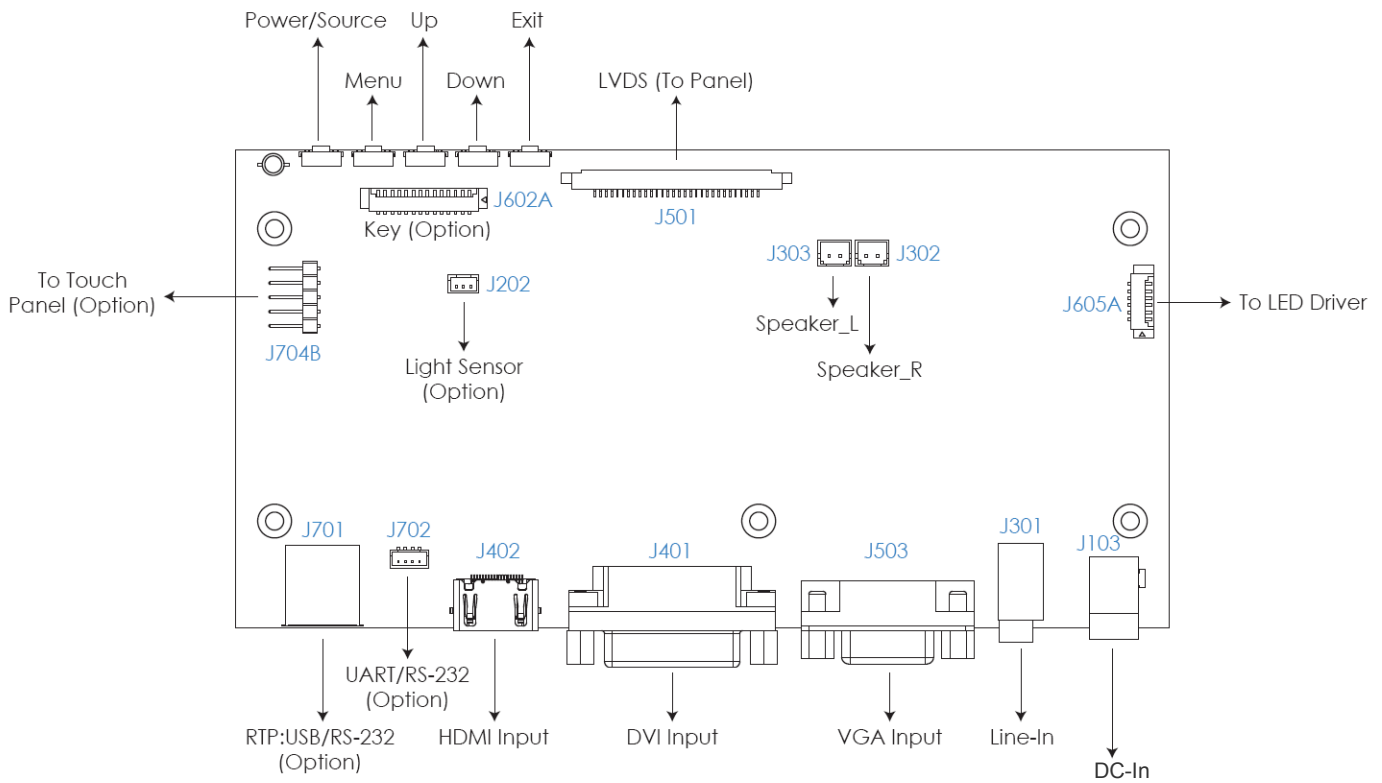

## 13. Accessories (Option)

Before you begin installing the KIT, please make sure that the following materials have been shipped:



A. LASTD12033-FDR



B. LAACD18000-FDR



C. LACABLE068-FDR



D. LACABLE069-FDR



E. LAVGA16000-FDR



F. LAUSB18000-FDR



G. LACABLE045-FDR



H. LACABLE070-FDR



I. LAVCD00002-FDR



J. LASPKR0004-FDR

- A. AC to DC Adapter (L:1500mm,100-240V<sub>AC</sub> 50-60Hz to +12V<sub>DC</sub> @ 3.3A,  $\phi$  2.1)
- B. Power Cord (L:1800mm, Plug Type B for USA)
- C. HDMI Cable (L:2000mm)
- D. DVI Cable (L:1800mm)
- E. VGA Cable (L:1600mm)
- F. USB Cable (L:1800mm)
- G. RS-232 Cable (L:1800mm, Null Modem)
- H. AUDIO Cable (L:1800mm)
- I. Touch Screen Driver CD Disk / User Manual
- J. Speaker (2W @ 4 $\Omega$  L:400mm \*2 Pieces)

## 14. Key Function by OSD

### 14.1 Menu Operation

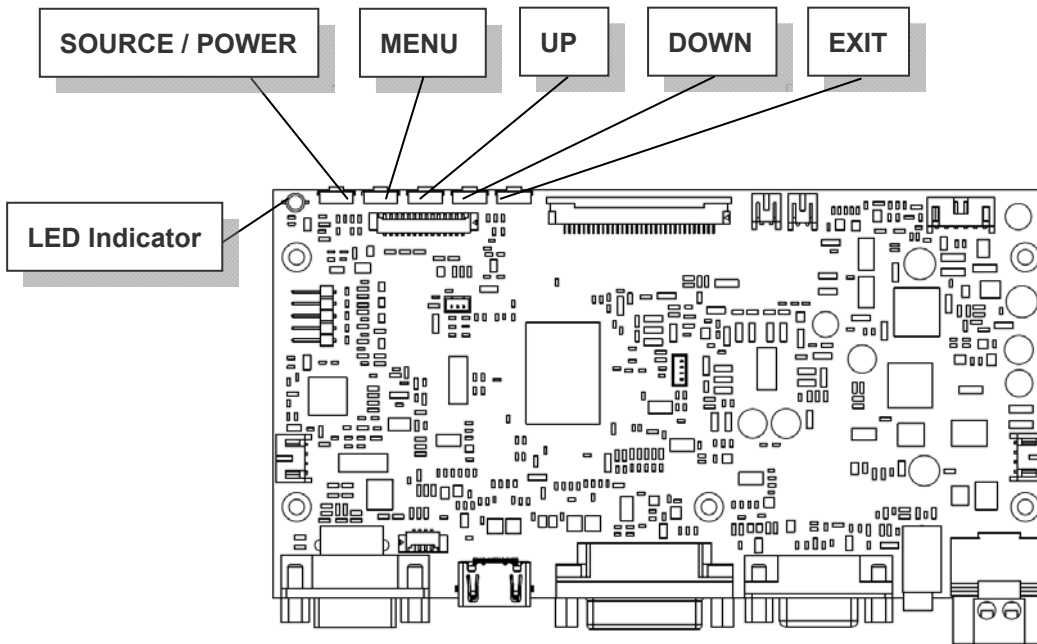

### OSD ICON Instructions :



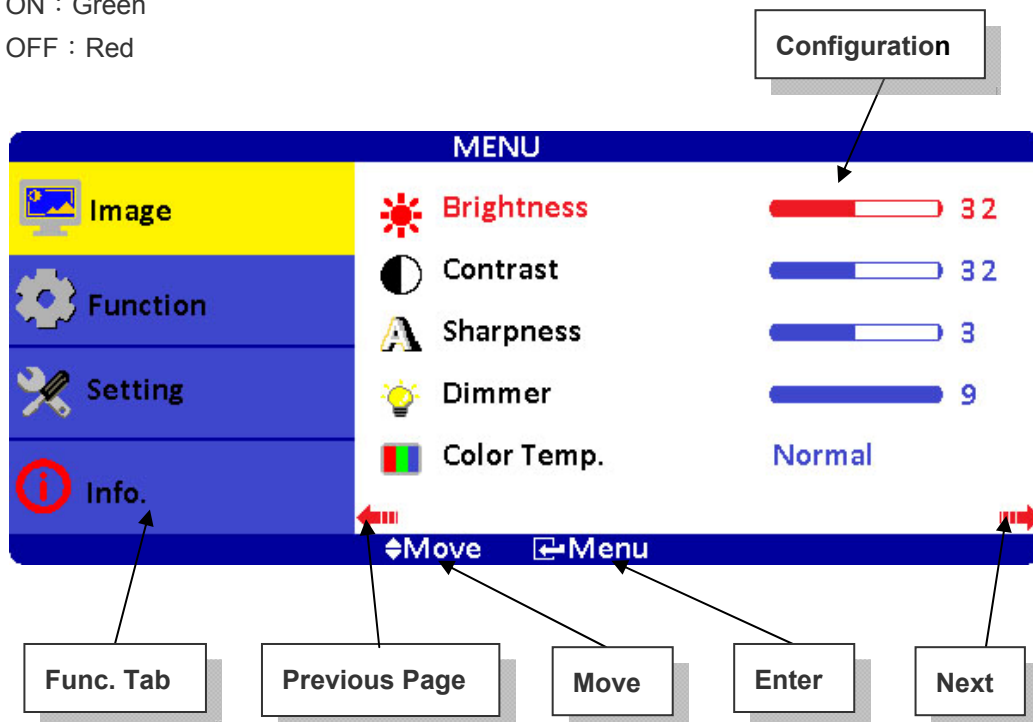







1. SOURCE / POWER : Input Source Switch / Power On/Off (※Press for 3 secs to turn off)
2. MENU : Enter
3. UP : Move Upward / Increase Value / Option Switch
4. DOWN : Move Downward / Decrease Value / Option Switch
5. EXIT : Return to Previous Page
6. LED Indicator
  - 6.1 Waiting : Flickering Green
  - 6.2 Power ON : Green
  - 6.3 Power OFF : Red



## Overview of the Menu :









### Image

Indicator	Meaning	Default	Adjustable range	Remark
	Brightness	32	0~63	Adjust-Bar
	Contrast	32	0~63	Adjust-Bar
	Sharpness	3	1~5	Adjust-Bar
	Dimmer	15	0~15	Adjust-Bar
	Color Temp.	Normal	Normal / Warm / Cool	
	H-Position	0	-25~+25	VGA only
	V-Position	0	-25~+25	VGA only
	Clock	0	-25~+25	VGA only
	Phase	32	0~63	VGA only
	Auto	By different resolution		VGA only
	Exit			



### Function

ICON	Meaning	Default	Adjustable range	Function	Remark
	Show Status	On	On / Off	Information of input source	ON: Show ; OFF: Hidden
	Blue Screen	On	On / Off	No signal input shows blue or black screen.	ON: Blue ; OFF: Black
	Auto Power On	On	On / Off	Modules turns on automatically w/o power input.	ON: Auto ; OFF: Manual
	Detect Source	On	On / Off	Auto detect input source.	ON: Auto ; OFF: Normal
	Auto Power Saving	Off	6s / 15s / 30s / Off	Modules go ready when no input source is detected.	ON: Auto ; OFF: Normal
	Auto Sleep	Off	15M / 30M / 60M / Off	Modules go sleep when set timing is out.	ON: Auto ; OFF: Normal
	Exit				

**Note :** After configuration is set, RESET won't restore to default setting.



## Setting

Indicator	Meaning	Default	Adjustable range	Remark
	Source	VGA	VGA / DVI / HDMI	
	Volume	32	0~63	
	Mute	Off	On / Off	On : Mute · Off : Sound
	Mirror	Off	On / Off	Left-Right Reversal
	Flip	Off	On / Off	Upside Down
	Language	English	English / 中文 / 日本語 / 한국의 / Française / Deutsch / Italiano / Española / Português	
	Reset			Restore to default
	Exit			



## Info.

### MENU

Image

Source : VGA

Function

Resolution : 1024x768

Setting

H-Position : 48.2KHz  
V-Position : 59.8Hz

Information

Program Ver : 1.00  
Command Ver : 1.00

◀ Move    ▶ Exit / Menu





## Hot Key When OSD Menu is Off :

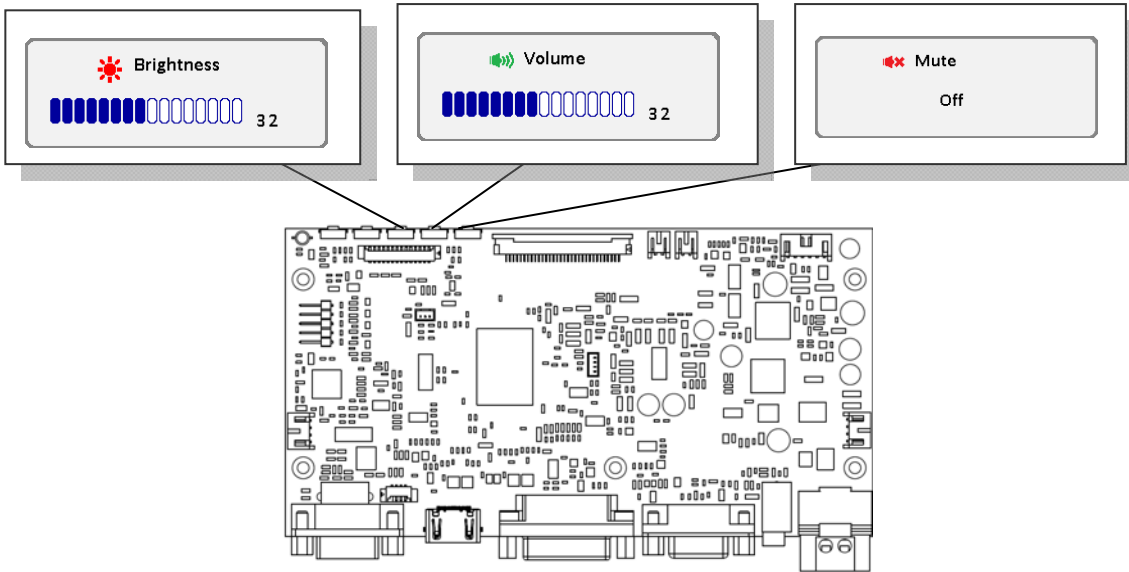



## Information of Input Source and Functionality :

The screenshot shows a Windows desktop with a blue background. A callout box labeled 'Input Source' points to the 'VGA 1024x768' display information. Another callout box labeled 'Resolution' also points to this information. In the bottom right corner, a system tray icon shows a warning triangle and the text 'Detect Source 5' and 'VGA 1'. Callout boxes point to these numbers, labeled 'Detect Source Remaining Secs' and 'VGA Mode Remaining Secs'.

[Source] : Input Signal Switch

## Overview of Input Signals :

Indicator	Interface
	VGA
	DVI
	HDMI