



FLAT DISPLAY TECHNOLOGY CORPORATION



This product is RoHS compliant



PKA1Gx11R2-00R Specification

2013.05.16 Version 0.3



ETPP

Embedded Touch Panel Platform

ADD: No.85, Sec. 1, Fuxing Rd., South Dist., Taichung City 402, Taiwan (R.O.C)

TEL: 886-4-22619577 FAX: 886-4-22623978

E-MAIL: fdt@fdt.com.tw http://www.fdt.com.tw



證書號碼 | 030450

證書號碼 | 87E02534

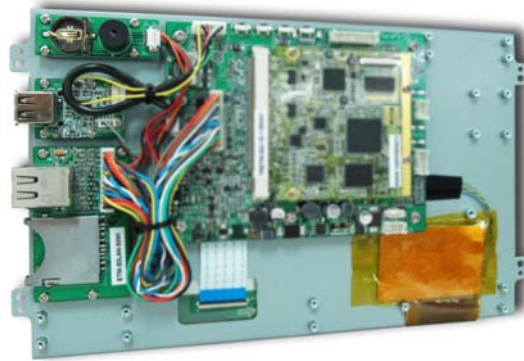
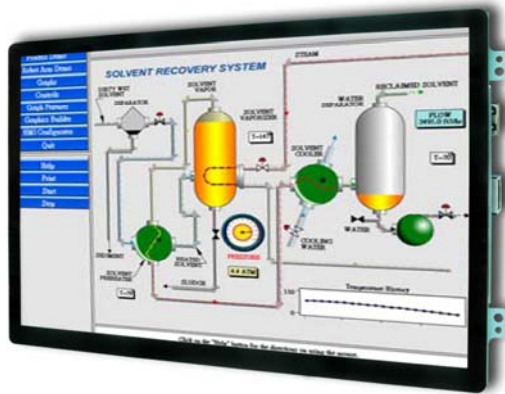

Features

■ System

- ARM Cortex-A8 @ 600MHz
- 256 MB LPDDR DRAM / 256 MB NAND Flash
- Android 2.2 / WinCE 6.0

■ Display

- 10.1"(16:9) Color TFT-LCD Panel
- Projected Capacitance Touch

■ Various Industrial Serial ports

- RS232 / RS485 / RS422

■ GPIO and Special IO

- General purpose I/O x 9
- I²C (100K/400kHz) x 1
- SPI x 2
- PWM x 1
- ADC (10-Bits) x 1

■ USB

- USB 2.0 x 1

■ Scan Key

- 3 x 3 Matrix keys x 1 (Option)

■ LAN

- Ethernet RJ-45 (10/100Mbps)
- WI-Fi IEEE 802.11 b/g/n (Option)
- PoE (Option)

■ Storage

- SD socket x1
- Micro SD x1 (Option)

■ Starter Kit

- Simply setting
- Quick Start
- Easy Learning

■ Free APPs source code

- Free C# APPs source code for WinCE 6.0
- Free JAVA APPs source code for Android
- Various APPs for special I/O





Specifications

System	
Processor	ARM Cortex-A8 @600MHz
System Memory	256 MB LPDDR DRAM / 256MB NAND Flash
2D/3D Graphics Accelerator	Power VR SGX 530
OS Support	Android 2.2 / Win CE6.0
COM1	RS232 (Option: UART/RS458/RS422)
COM2	RS232 (Option: UART)
USB OTG /HOST	USB2.0 HOST x 1 (OTG x 1 Option)
Ethernet /WLAN	RJ45 Port as 10/100Mbps (PoE Option)
Memory Card	SD / Option: TF (Micro SD)
Buzzer	85dB
Battery for RTC	CR1220
Wi-Fi	Wi-Fi IEEE 802.11 b/g/n (Option)
Scan Key	Max 3 x 3 (Option)
Function Key	Option
Audio	Earphone/MIC (Option) (Note)
GPIO	GPIO x 9, I ² C x 1, SPI x 2, PWM x 1, ADC x 1

LCD	
Panel Size	10.1"
Resolution (Pixels)	1280x800
Color	1,677K colors (24 bits)
Luminance / (with TP)	300/240 cd/m ² (Option)
View Angle	75/70/75/75
Backlight Lifetime (LED)	12K (Min)
Touch Screen	
Touch Panel Type	Projected Capacitance Touch
Power Requirement	
Power Input	+9~+36V _{DC} (PoE Option)
Power Consumption@+12V	7.5 Watts ± 15%
Environment	
Operating Temp.	-10~50°C
Storage Temp.	-20~60°C

Note: Must use condenser microphone only





Order Information

Parameter	PKA1G11R2-00R	PKA1G011R2-00R
OS	WinCE 6.0	Android 2.2
Touch Panel Type	Projected Capacitance Touch	Projected Capacitance Touch
COM1&COM2 Port	RS232 x 2	RS232 x 2
USB HOST A-type	⊙	⊙
SD Socket	⊙	⊙
Ethernet (10/100Mbps)	⊙	⊙
GPIO (SPI/I2C/PWM/ADC)	⊙	⊙
RTC Li-ion Battery (CR1220-3V)	⊙	⊙
Buzzer	⊙	⊙
Function Key (On Board)	⊙	⊙
Scan Key	Option	Option
Earphone / MIC	Option	Option
Dimension (WxHxD)	244.5 x 150.9 x 25.61mm	244.5 x 150.9 x 25.61mm
Weight	690 g± 10%	690 g± 10%

Note:

1. The assembling of panel and bracket is aimed for delivery, packaging and experiment. If the demand of shockproof and longterm fix, pls have it into consideration of mechanism design.
- 2: Scan Key Board 、Audio Board are optional accessories in PKA1G011R2-00R and PKA1G11R2-00R.

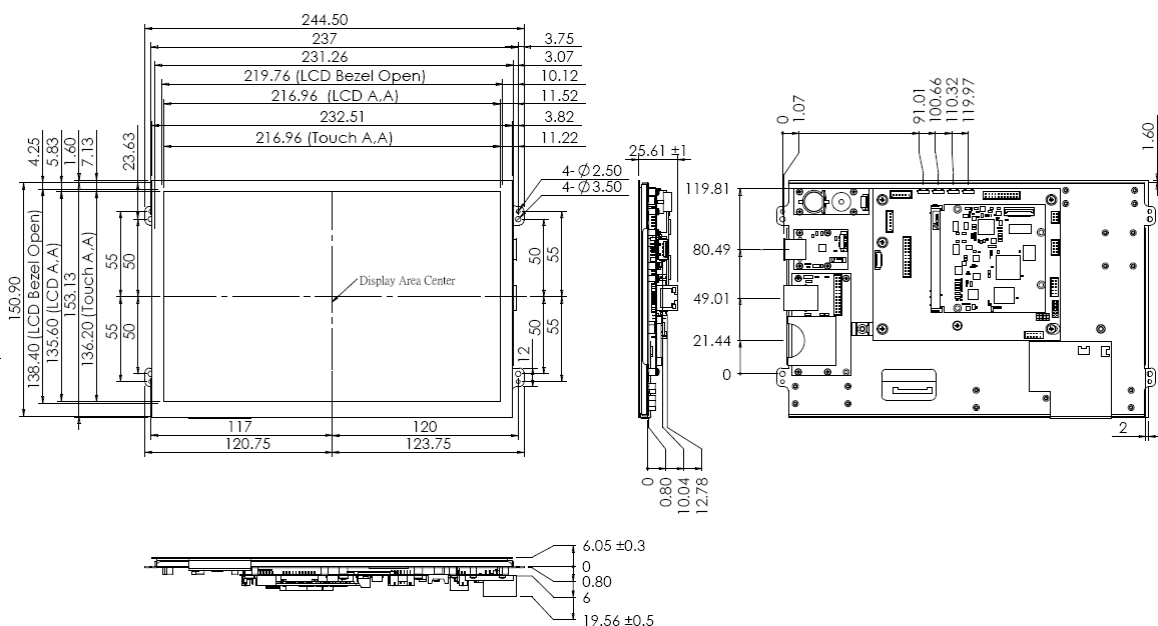

Dimension

PKA1Gx11R2-00R



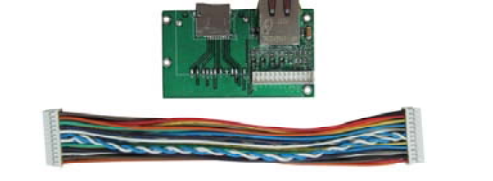
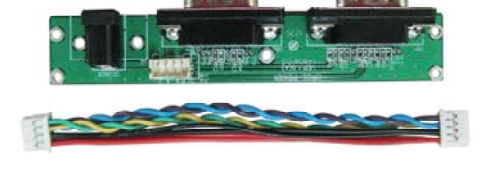
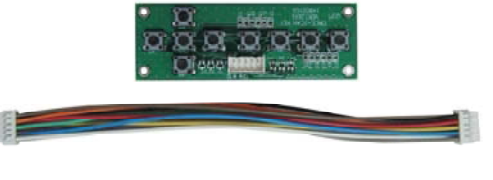

Accessories (Option)

NO.	Item	Order P/N	Picture
1	USB A-TYPE Board	LOUSBA0001-FDR With 6-6P (2.0mm Cable)	
2	Mini USB Board	LOUSBMNI01-FDR With 6-6P (2.0mm Cable)	
3	SD&LAN Board	LOSDLAN000-FDR With 24-24P (2.0mm Cable)	
4	TF (Micro SD) & LAN Board	LOTFLAN000-FDR With 24-24P (2.0mm Cable)	
5	Power & COM Board	LOPOWER007-FDR With 8-8P (2.0mm Cable)	
6	Scan Key Board	LK09K00001-FDR With 10-10P (2.0mm Cable)	





NO.	Item	Order P/N	Picture
7	Audio Board (Mic-in & Line out)	LOAUDIO003-FDR With 8-8P (2.0mm Cable)	
8	Wi-Fi	LOWIFI0001-FDR With 6P(2.0mm)-6P (2.0mm) Cable	
9	3A DC 12V Adapter	LASTD12030-FDR Match LAACD18000-FDR	
10	1.67A DC 24V Adapter	LASTD24167-FDR Match LAACD18000-FDR	
11	Power Cord Plug Type B for USA (D Type)	LAACD18000-FDR	